



User Manual

for Accellix Software Version 3.9.2

SPC-062 Revision 10

January 2025

© Copyright 2025 Accellix Inc. All rights reserved.

Accellix is a trademark of Accellix Inc.

All trademarks used herein are the property of their respective owners.

Table of Contents

1. Contents

2.	About the Accellix Platform	3
3.	Intended Purpose	4
4.	Principles of Operation	4
4.1.	Mode of Operation	4
5.	Overview of Operating Elements	6
6.	First Time Installation	8
6.1.	Product Contents	8
6.2.	Installation of Computer Hardware	8
7.	Starting the Instrument	9
8.	User Logins	10
8.1.	To Login	11
8.2.	Changing the Password	12
9.	Main Administrator Screen	15
9.1.	Personnel Settings	16
9.1.1.	To Edit Users and Log In Options	16
9.1.2.	To Add a User	17
9.1.3.	To Change Parameters	18
9.2.	Changing Printer and Time Settings	20
9.3.	Viewing/Exporting the Audit Trail	21
9.3.1.	Options for Exporting the Audit Trail	23
9.3.2.	Archiving Audit Trails	24
9.4.	General Administrator Functions	25
9.4.1.	Administrator Access	25
9.4.2.	Operator Access	25
9.4.3.	Copy Previous Results Function	26
9.4.4.	Delete Raw Data Function	27
9.4.5.	Edit Bead File IDs Function	28
9.4.6.	Errors Log Screen	29
9.4.7.	Network Function	32
9.4.8.	Auto-Classification Subscriptions Function	36
9.4.9.	Backup Options & Destination	36
10.	Operator Start Screen	38
11.	Operating the Accellix Platform	40
11.1.	To Run an Assay on the Accellix Instrument:	40

11.2. To Run a Multi-Cartridge Assay	50
11.3. Termination of an Assay Run	51
12. Shutting Down the Instrument	52
13. Troubleshooting	53
13.1. Cartridge Issues	53
13.2. Instrument Issues	55
13.3. All Administrators Locked Out	56
14. Handling Instructions	57
15. Maintenance	58
16. Assay-Specific Information	59
Appendix A – Technical Specifications	60
Appendix B – Symbols	62
Appendix C – Sample Product Label	62
Appendix D – Safety Information	63
Appendix E – User Support & Manufacturer Contact Information	64

2. About the Accellix Platform

The Accellix Platform revolutionizes flow cytometry by offering a simplified and automated workflow. The automated benchtop flow cytometer and pre-packaged and disposable cartridges opens up flow cytometry capabilities to a wider audience by replacing previously complex workflows. Instead of relying on highly trained individuals for assay preparation, sending samples to centralized labs, and professional flow cytometry analysts for data interpretation, Accellix streamlines and eliminates many of these steps, offering a fast, cost-effective, and efficient solution to obtain consistently reliable flow cytometric results in just 30 minutes—from automated sample preparation through to complete analysis—right in their labs.

For researchers and product developers across the biotechnology industry, the Accellix Platform is a flexible system to streamline the development of customized assays. The compact design of the instrument makes it ideally suited for point-of-need (PON) applications, seamlessly integrating into biologics manufacturing as an in-line analytical technology. Additionally, in the growing field of immunotherapy, Accellix plays a pivotal role in quality assurance and quality control (QA/QC) processes, reducing the time and costs associated with cellular sample processing while increasing reproducibility to ensure consistent and reliable outcomes.

In summary, the Accellix Platform automates and simplifies sample preparation, offering a user-friendly interface and reliable results through the use of single-use cartridges. The automated workflow increases reproducibility while reducing the reliance on trained professionals to provide powerful insights and reliable data for rapid decision-making to drive scientific innovation across the industry.

3. Intended Purpose

This document provides instructions for operating the Accellix Instrument. Refer to the relevant Technical Data Sheet and Instructions for Use (accellix.com/technical-resources) for instructions related to the Accellix cartridges and associated assay reagents. The Accellix Platform is intended to be used by technicians to perform flow cytometry analysis and ratiometric cell counting of analytes in biological samples, using cartridges designed specifically for use with the Accellix Instrument. The instrument is intended to be used with an Accellix cartridge as an automated analytical tool in cell phenotyping processes, for example during the manufacturing of Cell Therapies.

Two types of assays have been developed for the Accellix:

1. **Off-the-shelf assays:** Accellix provides a range of generic assays that are widely used throughout research and development of cell products. This includes the T cell panel for monitoring T lymphocyte populations, the TBNK panel for general lymphocyte populations and the stem cell panel for monitoring hematopoietic stem cell populations.
2. **Customized assays:** The flexibility of the Accellix Platform enables the migration of user-specific assays onto the instrument. Through a joint development process, customized cartridges can be developed based on the user's specific needs. For example, customized assays can be developed to streamline the QC monitoring process for manufacturing and releasing cell therapy products.

4. Principles of Operation

The Accellix Platform utilizes the general principles of flow cytometry, and integrates fluidic, optical, and electronic systems to measure and analyze optical and fluorescence characteristics of cells or other particles of interest.

Accellix enables the automation of the following three steps in the flow cytometry process:

1. **Biochemical sample preparation** (e.g., the assay): Accellix automates the preparation of the assay, ensuring consistent and reliable sample handling.
2. **Flow cytometric data acquisition:** The platform automates the acquisition of flow cytometric data, providing precise and high-throughput analysis of samples.
3. **Reporting and data acquisition:** Accellix reports detected events in a format that readily permits further analytical data processing. Users have the option of using algorithm-based auto-analysis of cell populations or manual analysis.

In rare instances, inaccurate results may occur due to incorrect usage of the instrument. The instrument should be used in strict accordance with this User Manual.

The Accellix platform is designed to enable an automated flow cytometry workflow, greatly simplifying the operational process. This enables individuals with limited laboratory experience to operate the platform effectively, without specialized skills or the need for extensive training.

4.1. Mode of Operation

The following steps describe the mode of operation of the Accellix system:

1. **Cartridge Selection:** The user selects the appropriate cartridge for the desired assay.
2. **Sample Introduction:** The user introduces assay specimen into the Accellix Cartridge following the specific instructions provided in the Technical Data Sheet and Instructions for Use. The cartridge is then closed to create a closed system.

3. **Assay Initiation:** The user taps the **Start** icon on the Accellix Instrument touch screen to initiate the assay process.
4. **Instrument Prompts:** The user follows the step-by-step instructions displayed on the instrument touchscreen.
5. **Cartridge Insertion:** The user opens the Accellix Instrument door, inserts cartridge, and closes the instrument door.
6. **Cartridge Identification:** The instrument automatically reads the identifying data for the cartridge (cartridge type, lot number, serial number, etc.) from the QR code on the cartridge.
7. **Sample Information Entry:** The user is prompted to enter a sample ID and kit number (note that the kit number may not be configured for all instruments). This information can be entered using the instrument's on-screen keypad, an external keyboard connected via USB port, or a barcode scanner.
8. **Sample ID Confirmation:** The user confirms that sample ID and cartridge type are correct before proceeding to run the assay.
9. **Progress Display:** An on-screen progress display shows the estimated time remaining until the completion of the assay.
10. **Automated Assay Execution:** The assay proceeds automatically, including the execution of the flow cytometric reading and analysis of the data acquired.
11. **Completion Notification:** Messages are displayed on the instrument screen to notify the user when the assay has been completed.
12. **Data Handling and Results:** Depending on the specific assay and the instrument configuration, the analyzed data may be copied to a file location in the instrument memory, to an attached external drive or Windows mapped network drive. If relevant, a results screen is displayed, and a printout is automatically issued (See Technical Data Sheet for the outcome designated for a specific test type.).
13. **Cartridge Removal and Disposal:** Once the assay is finished, the user removes the single-use cartridge from the instrument and disposes of it in a biohazard waste receptacle.
14. **Instrument Reset:** Once the instrument door is closed, the instrument screen returns to the **Start** screen, and the next assay can be started.

5. Overview of Operating Elements

The Accellix Platform consists of three components, including a benchtop flow cytometer instrument, a single-use cartridge, and customizable analysis software available separately.

The Accellix Instrument is operated using the touchscreen display, shown in Figure 1.



Figure 1: The Accellix Instrument

An image of the front (Figure 2) and an illustration of the back (Figure 3) of a single-use Accellix cartridge are displayed below. The Technical Data Sheet accompanying each Accellix assay gives a detailed description of how to use each specific Accellix cartridge type.

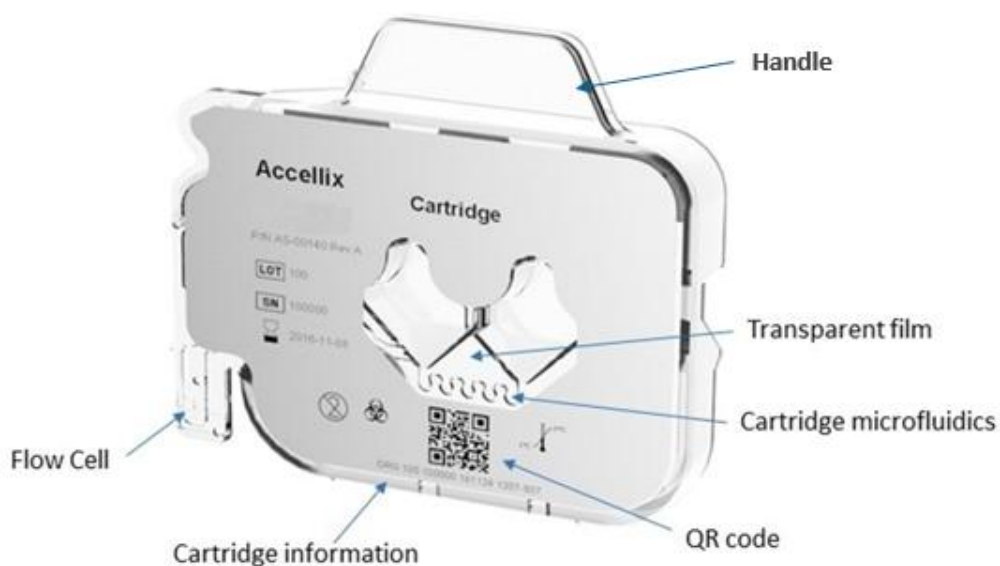

Figure 2: Image of an Accellix cartridge, as viewed from the front.

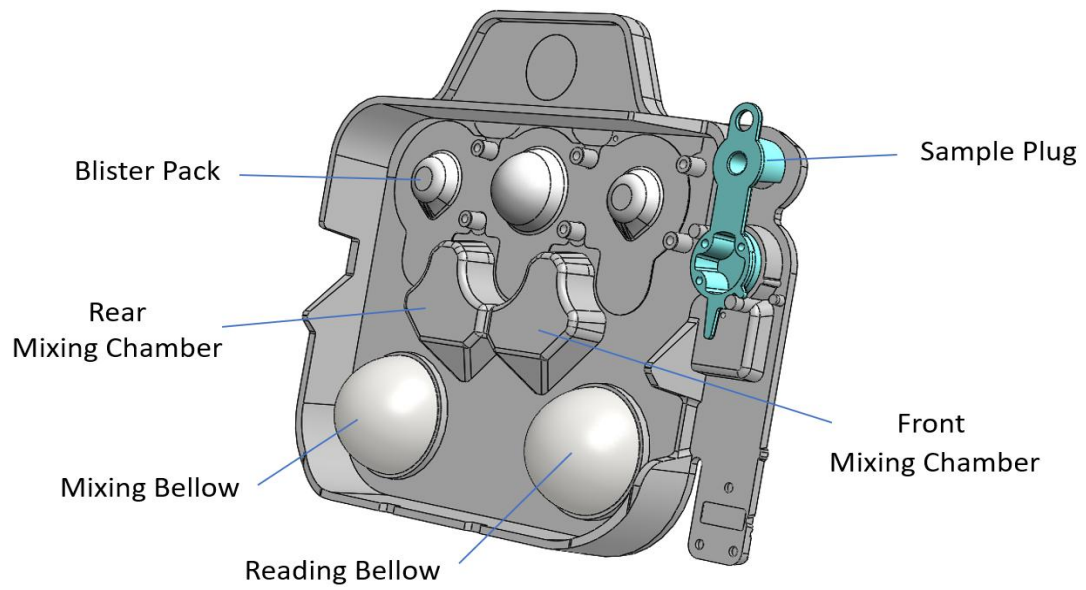

Figure 3: Illustration of an Accellix cartridge, as viewed from the rear.

6. First Time Installation

6.1. Product Contents

PART #	DESCRIPTION	QTY.
AS-00150	Accellix Flow Cytometer	1
CS-00070	Biohazard Bag	1
CSE-00624	Wi-Fi Antenna	1
CSE-00680	Power Supply Cable (interchangeable for multiple geographical regions)	1
CSE-00551	Ethernet Cable	1
CSE-00693	USB 3.0 32GB DOK for User Manual	1
CSF-00578	Vortex Foam Adapter	1

The unpacking and installation of the Accellix Instrument should only be performed by an Accellix Field Application Scientist to ensure proper setup.

6.2. INSTALLATION OF COMPUTER HARDWARE

Computer hardware components can be connected to the Accellix instrument using the ports on the rear panel (Figure 4).

Certain components such as the power cable, Ethernet network cable, and/or printer-USB cable, will be connected by an Accellix Field Application Scientist at the time of initial instrument installation.

The data files generated are intended to be copied to a user-selected destination. Users can connect an external drive at one of the four USB ports located on the rear instrument panel to copy the data files or to configure a network mapped drive as defined in section 9.4.7.

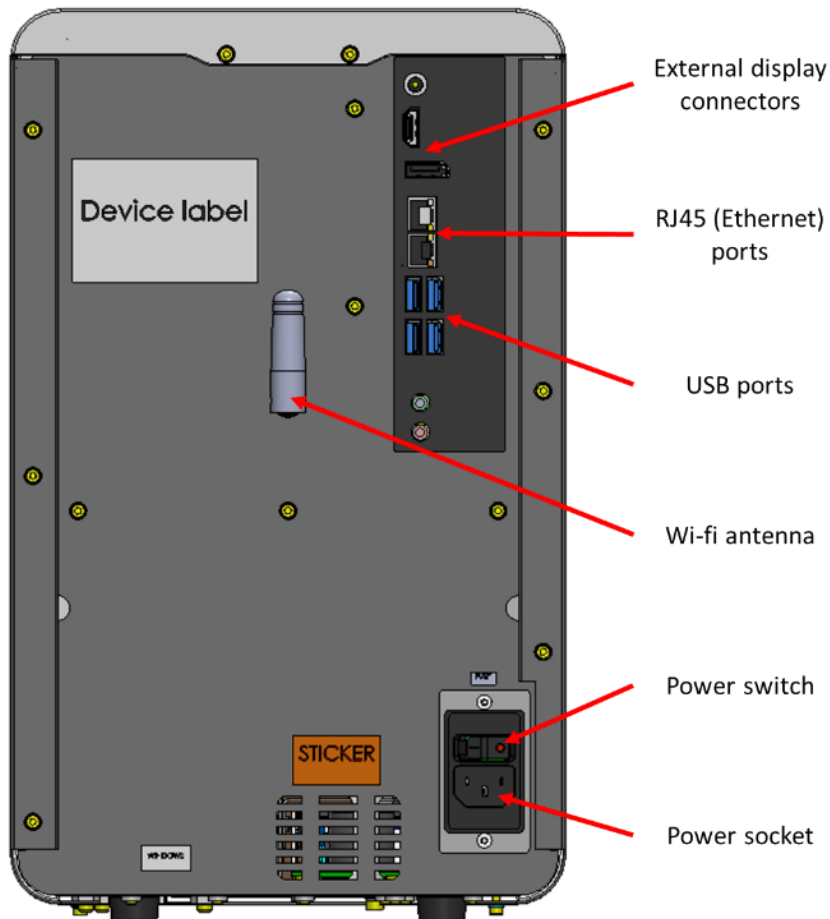

Figure 4: View of rear panel of Accellix Instrument

The following are connections that can be made to the Accellix Instrument with hardware components:

1. **Network connectivity:** To connect the instrument to the local area network using a network cable, an ethernet network cable should be connected to the RJ-45 port at the rear of the Accellix Instrument (Connection should be performed using a network cable less than 3 meters). Alternatively, the instrument can be connected to the internet via Wi-Fi.
2. **External memory drive:** A flash drive or external hard drive can be connected to the Accellix Instrument using one of the four USB ports located on the rear panel.
3. **Printer connection:** A printer can be connected using a printer-USB cable inserted into one of the USB ports on the rear of the instrument, or by connecting to a network printer by using an ethernet cable or through a Wi-Fi connection, at the time of installation **Peripherals:** If needed, e.g., for troubleshooting or general usability, a mouse and/or keyboard can be connected to the instrument using one of the USB ports on the rear panel of the instrument.
4. **Barcode scanner:** An external barcode scanner that supports 1D or 2D barcodes, e.g., for automatic input of the sample ID, can be connected to the instrument at one of the USB ports on the rear panel of the instrument.

7. Starting the Instrument

Turn on the instrument by switching the **Power switch** on the rear panel of the instrument to the '**ON**' position. While the instrument boots up, the display will inform the user that **System Self-check** is being performed (Figure 5 **Error! Reference source not found.**):

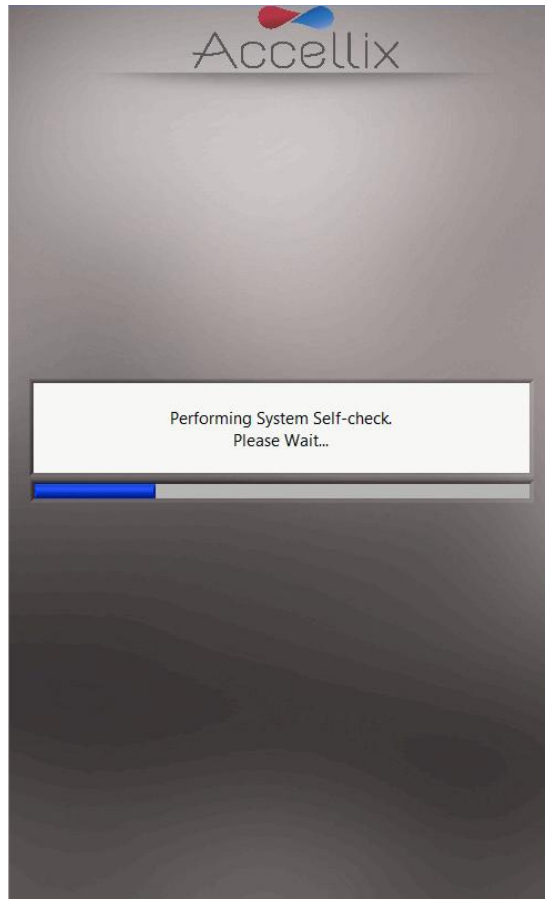

Figure 5: 'System Self-check' screen

If user logins are enabled the user login screen will appear (see Figure 6 in Chapter 8 below). If user logins are disabled, the main start screen will appear (see in Figure 33 in Chapter 10 below).

8. User Logins

Note: For the Accellix Platform to support 21 CFR Part 11 compliance, the login feature must be enabled. This can be done during installation by a certified Accellix representative . By default, the instrument's login feature is disabled and it's the customer's responsibility to submit a request to enable the login feature prior to the instrument installation.

If an instrument is configured to require user logins, the **User Login** screen (Figure 6) is displayed when the instrument starts up.

If user logins are not required, the instrument will start up as described in Chapter 10.

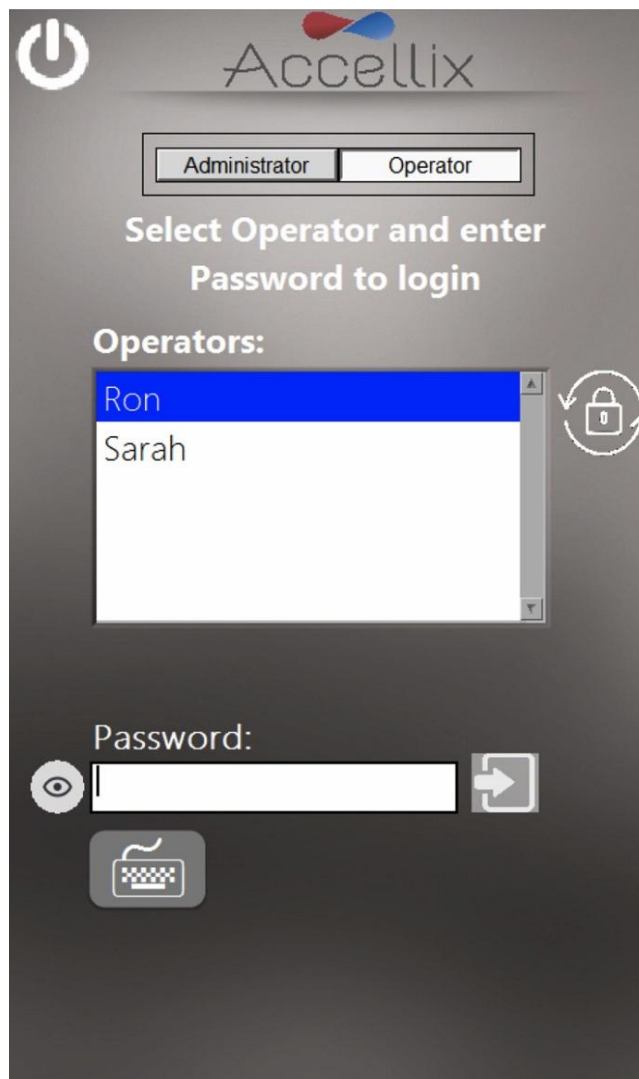

Figure 6: The User Login screen

There are two types of profiles with distinct capabilities: **Operators** and **Administrators**.

Log in as an **Operator** to run an assay.

Log in as an **Administrator** in order to perform the following tasks:

- Create and manage new users
- Configure login options
- Set system parameters (see Section 9.4 GENERAL ADMINISTRATOR)
- Copy, edit, print or export the audit trail
- Set various parameters including backup location, what files to copy when backing up, deleting old data, view errors, etc.

8.1. To Login

1. Select the user profile (Administrator or Operator)
2. Select a user from the list.
3. Enter selected user's password.
4. Tap the **Log in** icon  or hit the **Return/Enter** key on the keyboard.

Note: Tapping the **Keyboard** icon  will display a virtual on-screen keyboard.

Once the correct password has been entered the software will automatically go to the next screen. New users, or users who were previously locked out, cannot log in until they first set a new password (see section 8.2).

8.2. Changing the Password

There are a few instances where a user will need to change their password, including:

1. If password requirements have changed and the current password no longer fulfills the requirements (e.g., length, includes specific characters, etc.).
2. If the password has expired.
3. A user wants to change their password.
4. If the user is new and never had a password.
5. If the user was locked out (by entering the wrong password too many times) and then unlocked by an administrator.

To change the password tap the **Change Password** icon . For issues 1 to 3 above, the **Change Password** screen appears as in Figure 7:

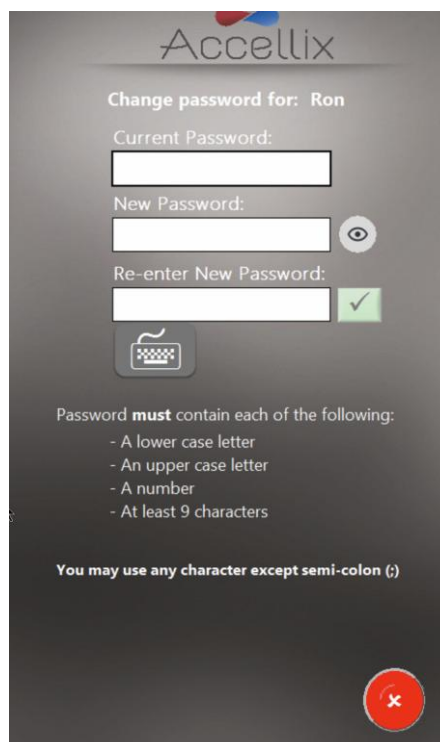

Accellix

Change password for: Ron

Current Password:

New Password:

Re-enter New Password:

Keyboard icon

Password **must** contain each of the following:

- A lower case letter
- An upper case letter
- A number
- At least 9 characters

You may use any character except semi-colon (;)

Red X icon

Figure 7: Change password screen (existing user)

For new or unlocked users the change password screen appears as in Figure 8:

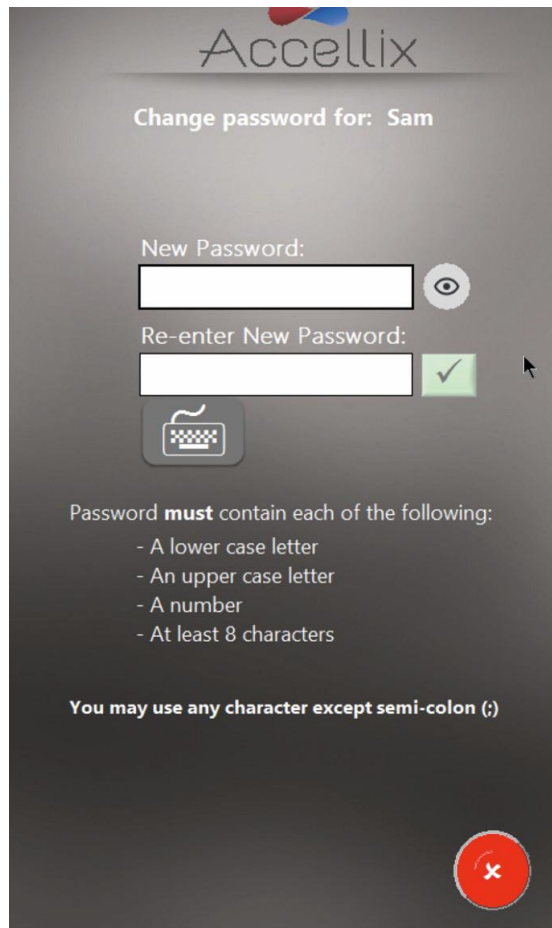





Figure 8 - Change password screen (new or locked out user)

Note: The list of required characters will depend on how passwords are configured on the device.

1. For existing users, the “Current Password” must be entered first. Entering an incorrect password more than the allowed number of times will lock out the user.
2. Enter the new password twice, identically.
 - a. Press the eye () icon to show or hide the password.
 - b. Press the cancel icon () to cancel changing the password.

The **Ok** icon () will only become active when the following password conditions are met:

- Both passwords entered are identical.
- All configured password requirements are met, as set by the Administrator as per section **9.1.3 To Change Parameters**.

The following configurable password requirements apply:

- The password must contain at least 1 upper-case letter.
- The password must contain at least 1 lower-case letter.
- The password must contain at least 1 number.
- The password must contain at least 1 special character (e.g., \$,#,@, etc.). **Note that semi-colon (;) is not allowed.**
- The password must have the minimum number of characters.

See Section **9.1.3 To Change Parameters** to see how to configure these options.

Note: The password may contain any symbol (e.g., #@%, except for a semi-colon (;)).

Note: The system also checks password history to ensure that the new password has not been previously used by that user.

3. **Note:** The **Start** screen will now have a **Log out** icon  in the top right-hand corner.

9. Main Administrator Screen

When an Administrator logs in, the **Main Administrator** screen (Figure 9) is displayed:

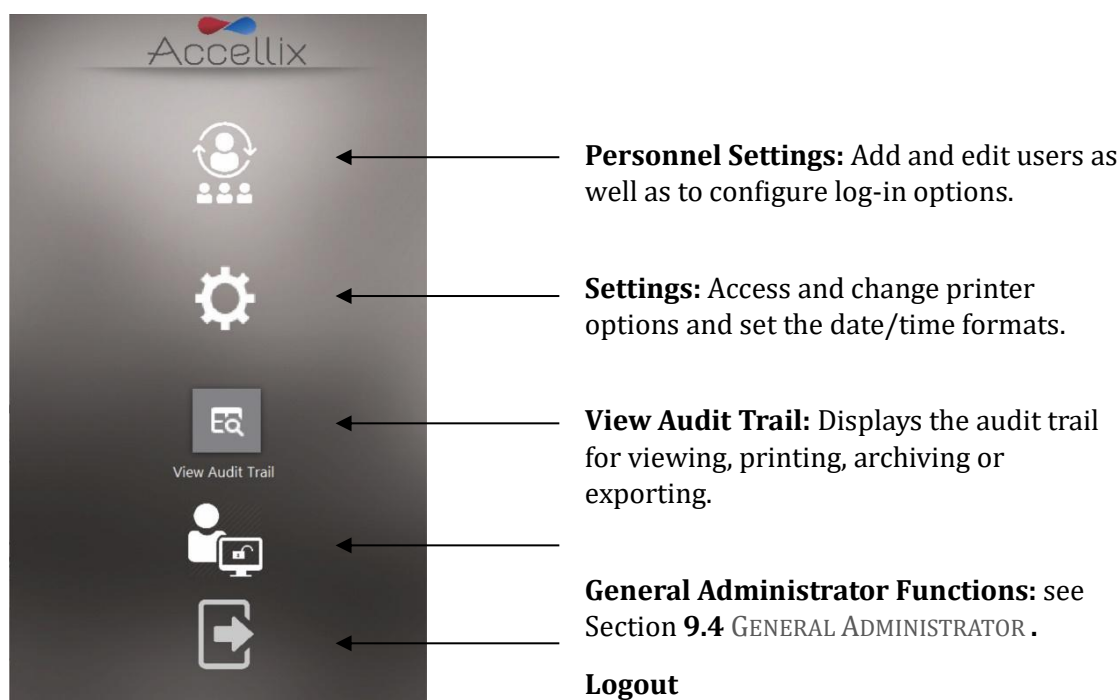



Figure 9: Main Administrator screen

Note: Depending on how your system is configured, the **General Administrator** icon may or may not be visible.

9.1. PERSONNEL SETTINGS

This screen allows an administrator to add users, set login parameters and define and set meta-data.

9.1.1. To Edit Users and Log In Options

1. Tap the **Personnel** icon . The **Personnel** screen (Figure 10) is displayed:

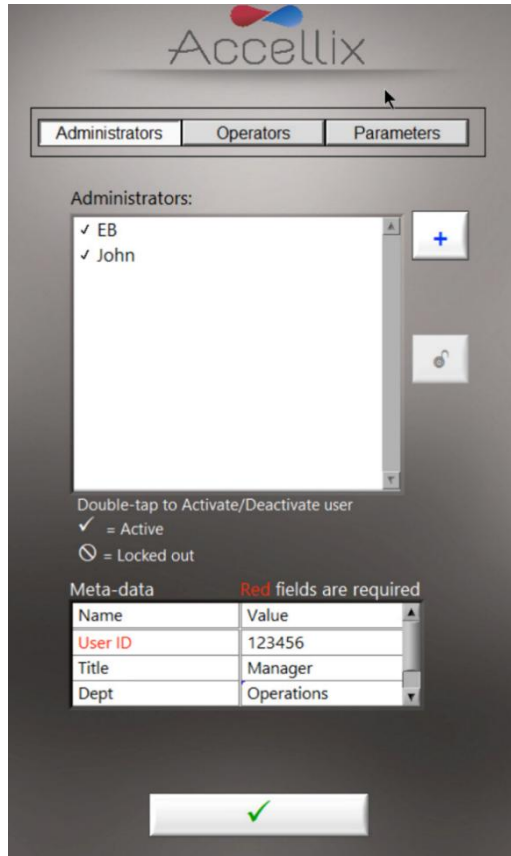







Figure 10: Personnel screen showing example Administrator users with example Meta-data

The **Personnel** screen has three options across the top: **Administrators**, **Operators** and **Parameters**. When either the **Administrators** or **Operators** option is selected, the software allows for the addition, unlocking, activating, or deactivating of an administrator or user. In addition, any meta-data, such as their personal information, contact details, or any other relevant data for that user can be edited.

Note: Required meta-data fields are indicated in red. The window cannot be closed until all required fields are filled.

2. Double tap on a username to toggle activation and deactivation.
3. Tap the **Ok** icon  to save any changes.

ICON KEY:

Check mark		User active
No check mark		User inactive (cannot login)
Locked out		User locked out (cannot login)
Unlock		Select username and tap unlock
Add		Add user (Figure 10)

9.1.2. To Add a User

1. Tap the **Add** icon . The **Add User** screen (Figure 11) is displayed:

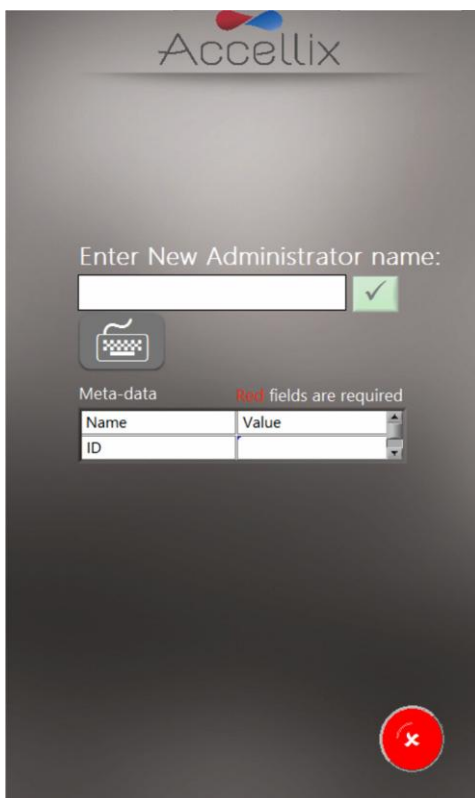



Figure 11: Add User screen

The **Ok** icon  only becomes active when a valid username is entered.

Note: A username cannot be blank or consist of only spaces, and it cannot contain any of the following characters: * \ / " : < > ? | _ % . # & { } \$! ' @.

Note: The meta-data fields will only appear if meta-data has been defined.

Note: If an **Operator** and **Administrator** have the same username, they are considered by the Accellix system to be the same person and the same meta-data will be used for both.

Note: An administrator cannot disable him/herself.

2. Enter a new username and tap the **Ok** icon. The username is added to the list of users.

Note: All new users are required to set their passwords when logging in for the first time.

9.1.3. To Change Parameters

1. Tap **Parameters** at the top of the **Personnel** screen. All changeable login parameters (Figure 12) are displayed:

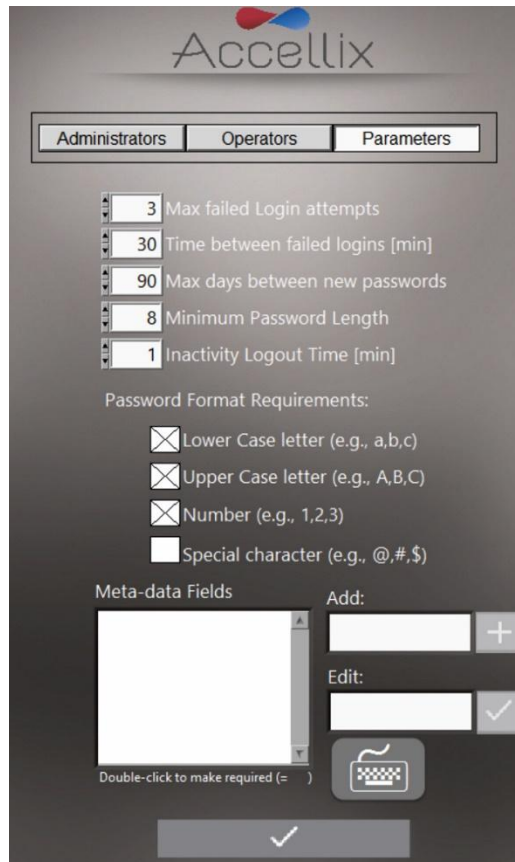



Figure 12: Login Parameter Options

2. Set parameters as desired and tap the **Ok** icon . The changes are saved.

The following parameters can be set:

Max failed login attempts: Sets the maximum number of times a user can attempt to login before being locked out.

Time between failed logins: Sets the number of minutes to wait before resetting “number of failed attempts” to zero if the “Max failed Login attempts” has not been reached.

For example, if a user is allowed 3 attempts to log in before being locked out but only enters 2 incorrect passwords, and the “Time between failed log ins” is set to 30 minutes , then after 30 minutes that user can try an additional 2 times as the “number of failed attempts” counter is reset to 0. If the wrong password is entered 3 times within 30 minutes, the user will be locked out and an administrator will need to unlock the user account.

Max days between new passwords: Sets the number of days that elapse between the previous password change and when the user is required to change it again.

Minimum Password Length: Sets the minimum number characters required in a password. Note that if this number is increased after users have created valid passwords, their passwords will become invalid and they must change them.

Inactivity log out time: Sets the amount of time (minutes) with no activity after which the user will be automatically logged out.

Password format requirements: Passwords must contain at least one character for each type selected. For example, if the requirement “Lower Case letter” is selected, a user’s password must contain at least one lower case letter.

Add (Meta-data Fields): Allows for adding a new meta-data field (type the name of the new field in the **Add** text box and tap the **+** button).

Edit (Meta-data Fields): Select a field name in the **Meta-Data Fields** list on the left. The name appears in the **Edit** text box on the right. Edit the field name and tap the **Ok** icon  to the right.

Double-click to make required (=✓): Double-clicking on a meta-data field in the **Meta-Data Fields** list box will make it “required”, i.e. mandatory, and a checkmark (✓) will appear to the left of that meta-data field.

Note: Double-clicking on a “required” meta-data field will make that field optional and there will be no checkmark next to it (✓).

Delete: Use the Delete icon () to remove a meta-data field. If a meta-data field is removed, any data added to users for this field is removed (e.g., if the Meta-data Field “Dept” is removed and “Tom” has “Engineering” as his meta-data for that field, “Engineering” is removed from Tom’s meta-data).

Note: Meta-data is intended to allow for additional, non-critical data about each user to be entered. For example, some possible meta-data fields are: “email”, “Employee ID”, and “Department”. This data is generally “non-essential” but can be useful for certain organizations.

9.2. CHANGING PRINTER AND TIME SETTINGS

Tap on the **Settings** icon () to display the **Settings** screen (Figure 13), which allows an administrator or operator to select a specific destination printer and to change the auto-printing feature after an assay completes.

If the checkbox next to the “**Automatically print results to:**” field is selected, the Assay Results.PDF file will be sent to the selected printer after each assay completes. If the checkbox is not selected, the results will not be printed automatically at the end of a test run. However, even if the automatic print function is not selected, the user can manually print the results from the **Results** screen once the test is completed.

The list of printers includes the printers that are configured on the instrument. A new printer can be added by an Accellix representative.

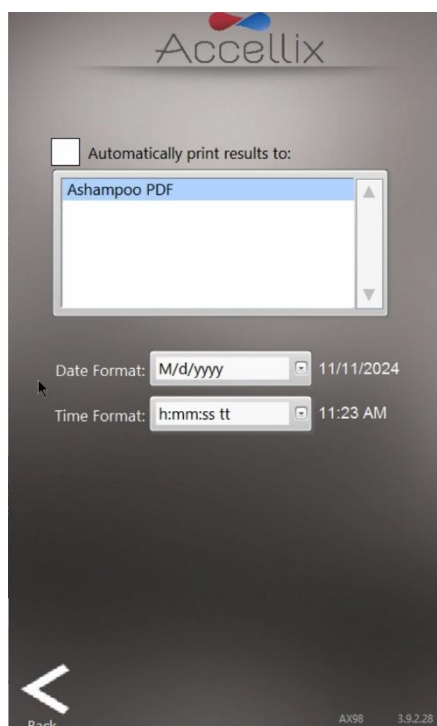

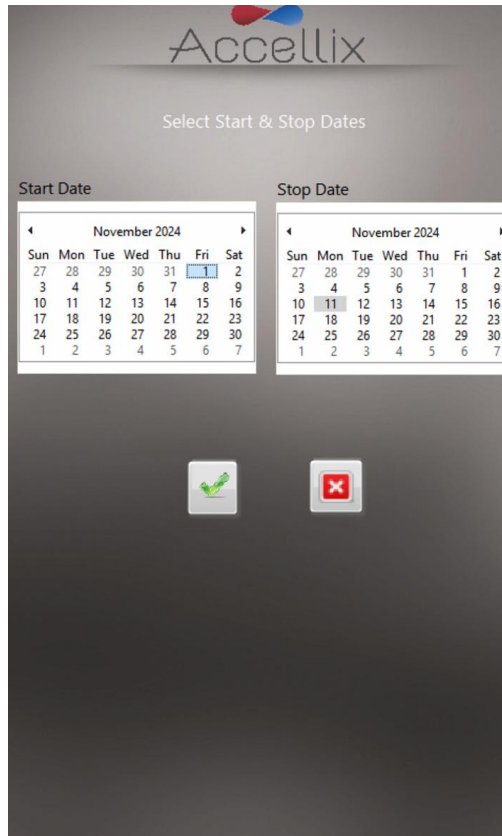

Figure 13: Changing Printer Settings as an Administrator

In addition, an administrator can set the date and time formats for all dates and times used by the instrument (this feature is not available to operators). After changing a time or date format, the current time and date will be displayed in the updated format.

Finally, this screen displays the name of the instrument and the software version number in the lower right-hand corner.

Tap the **Back** icon () to return to the previous screen.



Note: It is recommended to review the audit trail regularly to ensure no data backup issues have occurred (See section **13.2-INSTRUMENT ISSUES** for more information).

9.3.1. Options for Exporting the Audit Trail



1. To export either the entire Audit Trail or a date-filtered Audit Trail, tap the **Export Table**  icon which displays the window illustrated in Figure 15 to select a location and enter a name for the file.





Figure 15: Save File screen

Double-tap the desired folder in the list to open it. The drop-down menu can be used to navigate back up the hierarchy of folders, if needed.

The Ok button () will be active once at least one character has been entered in the file name field. Tapping this button will save the file using the entered name in the current location.

The Cancel button () will cancel the export and close this dialog window.

The New Folder button () presents a dialog for creating a new folder in the current folder. This button is only active when viewing the list of Drives.

2. To export a previously archived Audit Trail, tap the **Export Archived**  icon which will display the screen in Figure 16:

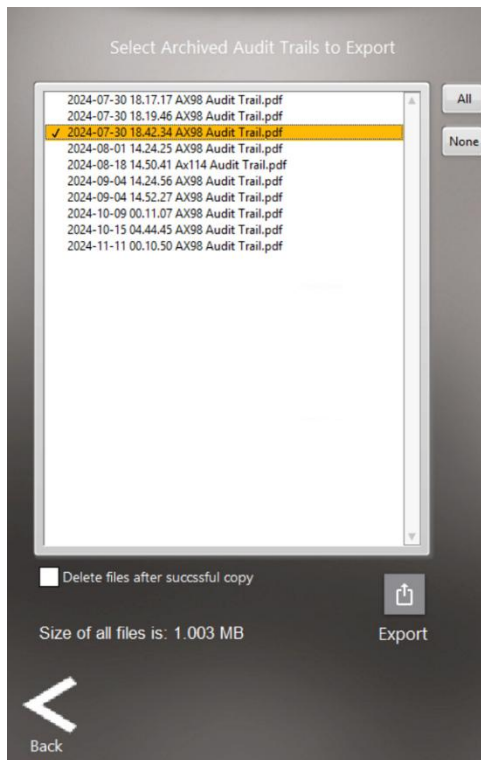

Figure 16: Export Archived Audit Trails screen

One or more archived Audit Trails can be selected for exporting. Double-clicking on an archived Audit Trail in the list selects it (represented by a checkmark next to the name). Double-clicking again on the same file will unselect it (removing the checkmark).

Selecting the **All** button will select all the files in the list while selecting the **None** icon will unselect all the files in the list.

Administrators have the option to delete any files that are selected for export after they have been successfully copied by selecting the **Delete files after successful copy** checkbox.

The **Export** icon is enabled when one or more files are selected.

A message will appear after the export has completed indicating whether or not it was successful.

*Archived Audit Trails are exported to the **Exported Audit Trails** folder in the backup location.*

3. Tap the **Printer**  icon to print the displayed table to the default printer.

9.3.2. Archiving Audit Trails

Administrators can manually archive the Audit Trail by tapping on the **Archive Now** button (immediately below and to the left of the Audit Trail table in Figure 14). This action will create a new PDF of all entries in the Audit Trail since the last archive. If all entries in the Audit Trail have been archived, this button will be disabled.

In addition, by using the **Auto Archive** Audit Trail drop-down menu, an administrator can configure the software to automatically archive Audit Trails every day, 7 days, 30 days, 90 days, 180 days or 365 days. Setting the drop-down menu to Never will turn off auto-archiving of the Audit Trail.

If the **Auto Archive** drop-down menu is set to any option except “Never”, it is possible to have auto-archived Audit Trails automatically copied to the backup location by selecting the **Auto-export** checkbox. Auto-exported archived Audit Trails are copied to the **Exported Archived Audit Trails** folder on the backup location.

9.4. GENERAL ADMINISTRATOR FUNCTIONS

The General Administrator Functions screen (Figure 17) can be accessed by tapping the  icon either on the Start screen (if that is enabled- see Figure 33) or the main Administrator screen (Figure 9).

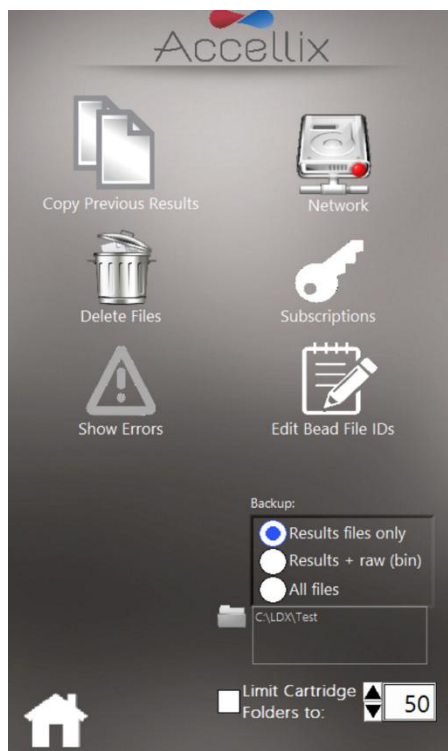

Figure 17: General Administrator Settings screen

Note: In the case that one or more files were not able to be copied, the gray Show Errors icon will be yellow to indicate that not all files were copied. 

9.4.1. Administrator Access

For administrators, this icon is accessible from the Main Administrator screen (see Chapter 9 Figure 9) after logging in and requires no further password.

9.4.2. Operator Access

For operators, or if logins are not enabled, this screen can be accessed from the Start screen by tapping on the Admin Function icon (center-bottom icon in Figure 33), however operators (or all users if logins are not enabled) will have to enter a password to access this screen (Figure 18):

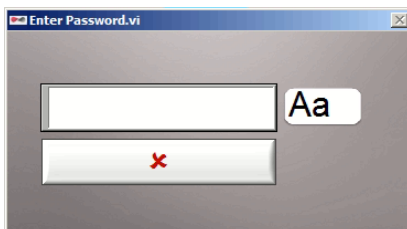

Figure 18: Admin User Password window

Note: Access to the General Administrator Settings is not available by default to operators (when logins are enabled) and is subject to customer’s decision at time of installation. It can only be configured by an Accellix representative. Enabling this option should be made while carefully considering any implications for 21 CFR Part 11 compliance.

Note: The password window will automatically close once the correct password has been entered.

Note: The user authorized to act as the instrument administrator should contact Accellix Support at support@accellix.com and provide the Instrument Serial number (located on the back of the instrument) to receive the Admin password.

9.4.3. Copy Previous Results Function



Using the **Copy Previous Results function**, admin users can manually copy or move results files from past test runs by selecting a date range (Figure 19) and tapping **Copy Now**. Cartridge data folders created between the selected dates are displayed below the two calendars. Note that customer selects what data will be copied, as described below:

- If **Results files only** is selected, only the assay results (Assay Results.pdf and Summary Results.txt) and the associated .csv, .fcs, and PDF files are copied or moved:
 - If the **Include raw binary files** checkbox is selected, the software also copies or moves raw data files, as well as the .csv, .fcs and PDF files.
- If **Entire folder** is selected, the entire data folder (including .csv, .fcs, PDF, .bin, .png etc.; >1.7 GB) is copied or moved.
- If **Copy** is selected, the software only copies files based on the above selected options.
- If **Move** is selected, the software copies the files based on the above selected options and then deletes the original files once the file copy is successful. Please note that moved files will be permanently deleted from the original location.

The copy destination is selected in the **Destination Location** function, as explained below (see Section 9.4.9.2)9.4.9.

The screen displays how much data will be deleted and how much space is currently available on the internal hard disk.

Note: Double-click to select or unselect individual folders. Clicking on the “Select all” button will select all folders in the list. Clicking on the “Deselect all” button will deselect all folders in the list and the “Select all” button will reappear. If necessary, deselect and/or reselect a specific folder by double-clicking on it.



Figure 19: Copy/Move Results Files screen

A progress bar will appear at the bottom of the screen to indicate the progress of the copy/move.

During the copy/move, a cancel button appears and allows the process to be aborted.

During copying, it is not possible to use the Back button to return to the previous screen until either the process finishes or is aborted.

9.4.4. Delete Raw Data Function



An administrator can use the **Delete Raw Data Function** to free up space on the internal hard disk of the instrument (Figure 20).

Files/folders can be deleted either on or before a specified date (“On or before”) or between a set of dates (“Between dates”).

Note: If data is backed up on the internal hard disk (C:\), there is an option to delete files from either the main directory or the backup directory.

Note: The software will not delete any files in the selected folders which have not been backed up.



These files must be backed up before they can be deleted. Tapping the Delete icon () deletes large raw data files created from each test run executed on or prior to the date selected in the date field (Figure 20).

- The “Cartridge Folders with data to be deleted” window displays all folder names to be deleted.
- The space to be freed up (in GB) is displayed at the bottom of the screen.

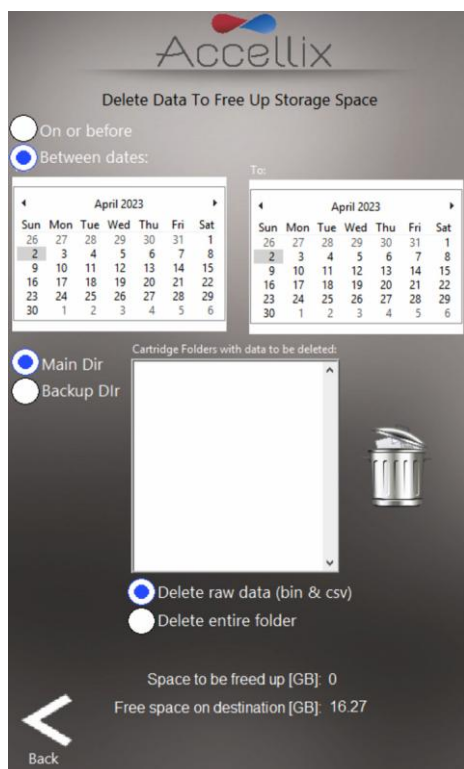

Note: The result output files, e.g. '.fcs' file, results report files, etc. for each test run on the instrument are always retained on the internal instrument memory; they will not be deleted when this function is used unless the Delete entire folder checkbox is checked.

Warning: Selecting the **Delete entire folder** checkbox and tapping on the **Delete** icon deletes all data folders displayed in the list that have been successfully backed up. This action is **NOT** recoverable — data will be permanently deleted.

Figure 20: Delete Raw Data files screen

9.4.5. Edit Bead File IDs Function



The **Edit Bead File IDs** function **Edit Bead File IDs** window displays a list of all available bead lot files for all assays that use these files (Figure 21). Currently, only the QC assay (Q1001-1L) uses bead lots. Bead lot files contain Bead Lot Numbers (BLN). For those assays which require this feature, the files contain calibration values used in analysis of these assays. These values can change from lot to lot.

Note: Individual bead lots can be deleted if the original file needs to be replaced with a newer version.

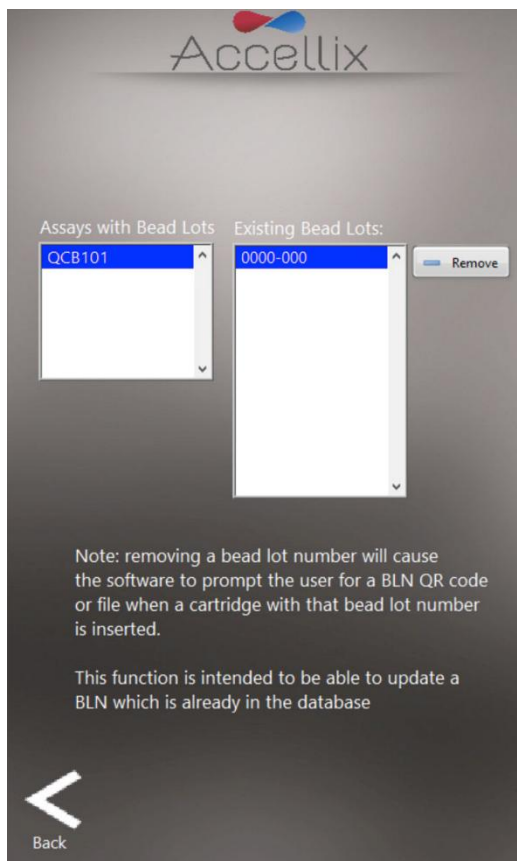



Figure 21: Bead Lot IDs screen

9.4.6. Errors Log Screen

The Errors Log screen can be displayed by clicking on  or  from the Administrator

Functions screen (or on  from the Start screen). The yellow icon indicates that errors occurred when backing up files. This screen has two functions:

- The **Error Log** tab displays a list of all errors which have occurred on the instrument (Figure 22). Tap the printer icon  to print the log file. Tap the **Export PDF** icon to export the table to a PDF file.

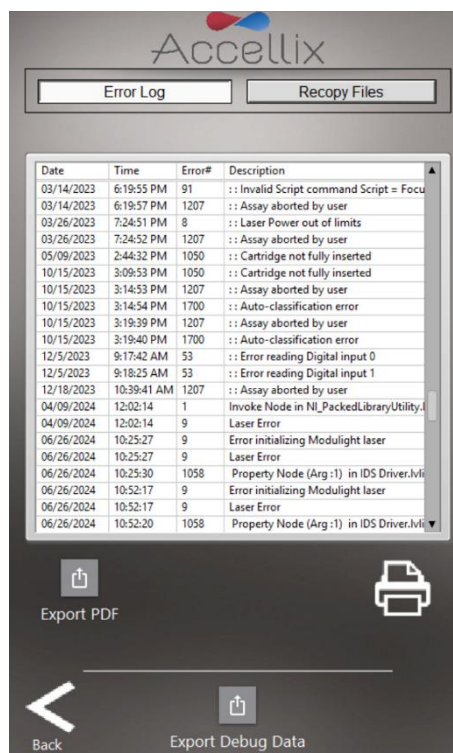
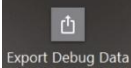

Figure 22: Error Log screen

Note: Pressing the **Export Debug Data** icon  will export a compressed (zip), password-protected debug data file to C:\LDX\Data\Support folder. Only use this button under the guidance of an Accellix representative. After the Debug data file is exported, use the Copy/Move Results Files screen (Figure 19) and select today's date so the Support folder is **visible** in the list. Select double

click) the Support folder and then export this folder by selecting “Move”, which will copy the entire folder contents to the backup location and delete the content once the folder is copied.

Note: The Error Log is only accessible by administrators.

2. The **Recopy Files** tab displays all of the data files that have not previously been copied (Figure 23).

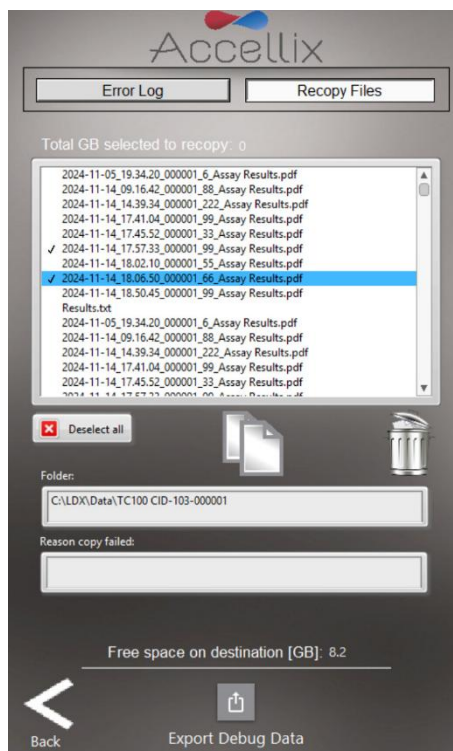





Figure 23: Recopy Files

One or more files can be selected by double-clicking on the files in the list. Clicking on the “Select all” button will select all files in the list and the “Deselect all” button will appear.

Only after at least one file has been selected will the Recopy Now  and Delete From List  buttons become active.

Note: The Delete From List button is only visible for Administrators.

When a file in the list is selected, any folder(s) contained in that file are displayed in the “Folder” field and the reason it failed to copy is displayed in the “Reason Copy Failed” field.

Clicking on the Recopy Now button  will attempt to recopy the selected files to the current destination location. Because there may be restrictions on the destination drive regarding deleting or overwriting existing files, the software will automatically auto-increment file names when recopying if that file already exists on the destination drive (e.g., if “Assay Results.pdf” already exists, the software will create “Assay Results_01.pdf” when recopying).

Note: The Recopy Files tab is disabled if there are no files to recopy. Similarly, the  icon is only visible if there are files that need to be recopied.

9.4.7. Network Function



The **Network function** screen (Figure 24), has 4 tabs:

- Map Drives: The Map Drives tab allows the user to map a drive letter to a network drive.
- IP config: The IP config tab allows the ethernet port to be configured dynamically or with a static IP address.
- WiFi: Allows the device to connect to a WiFi network and notifies the user once connected successfully.
- LIMS: Configures the device to save data to LIMS.

1. The Map Drives tab (Figure 24) allows the user to map a drive letter to a network drive.

a. **To map a drive:**

- Select a drive letter.
- Enter the network address.
- Enter the username.
- Enter the password.

(Please follow guidelines and requirements of your IT department.)

- Click on “Save & Map”

Note: To view the password in clear text and hide it again, use the **View Password** button ()

b. **To unmap a mapped drive:**

- Select the drive to unmap.
- Click on the “Unmap” button.

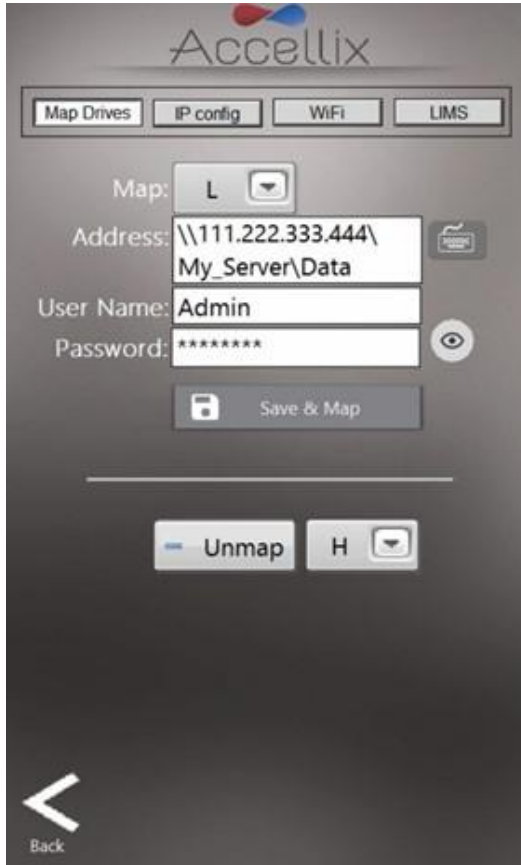

Figure 24: Network screen: Map Drives tab

Note: When mapping a drive as a backup location, don't forget to set the backup location to that drive.

2. The IP config tab (Figure 25) allows the TCP/IP address for either of the Accellix instruments' two Ethernet ports to be configured dynamically or with a static IP address.

To set a static IP:

- Select the desired port from the drop-down menu.
- Select **Use the following IP address** radio button.
- Fill in the IP address, Subnet mask, and Default Gateway (Please consult with your internal IT department).
- Click on the checkmark icon (✓).

Note: If any errors arise, they will be displayed below the Default Gateway.

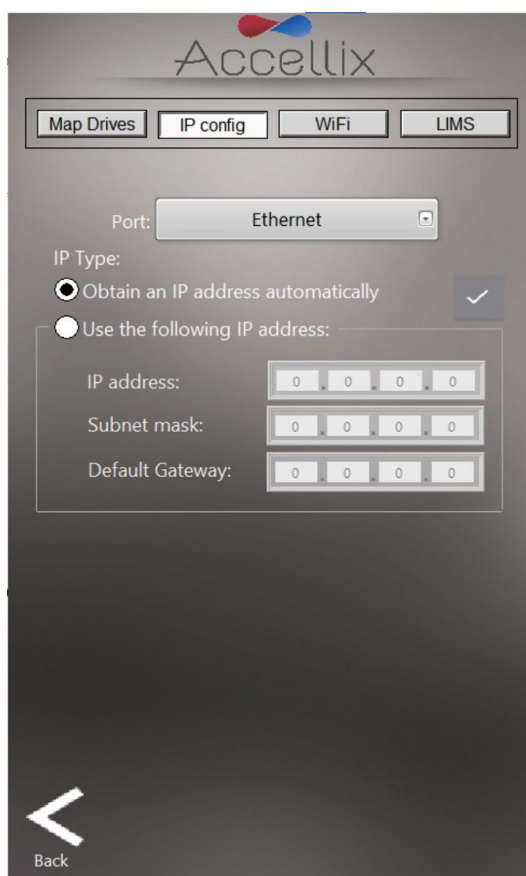

Figure 25: Network screen: IP Config tab

3. The Wi-Fi tab (Figure 26) is used to connect to a Wi-Fi network. To connect:
 - Select a Wi-Fi Network from the drop-down menu.
 - Enter the password.
 - Click on the connect button (➡).

Note: A red X (❌) indicates that the network is not connected.

Note: A green checkmark (✅) indicates the network is connected.

- To disconnect, click on the red button (❌) that appears when connected.
- The Refresh button (🔄) will refresh the list of available Wi-Fi networks.



Figure 26: Network screen: Wi-Fi tab

If the backup location has been set to a folder on the C: drive (see section 9.4.9.2, Figure 30), the options shown in the bottom half of Figure 26 are displayed. Here it is possible to share the backup location on C: drive with the network by clicking the Start Sharing button. Once the folder has been shared, the Stop Sharing button appears which will stop sharing that location when pressed.

4. To configure a system to save data to the LIMS system, select the LIMS tab (Figure 27). To enable the system to save data to the LIMS system:
 - Click on the LIMS tab at the top of the screen.
 - Select the “Save results to LIMS” checkbox.
 - Select the “Print after saving to LIMS” checkbox, if applicable.
 - Enter the LIMS address.

Note: If any errors arise, they will be displayed below the LIMS address field.

Note: LIMS can only function after a customer-specific configuration has been performed (this configuration is independent of the Accellix software, but the Accellix software needs this configuration in order to communicate with the LIMS). Please contact support@accellix.com if this configuration is needed.

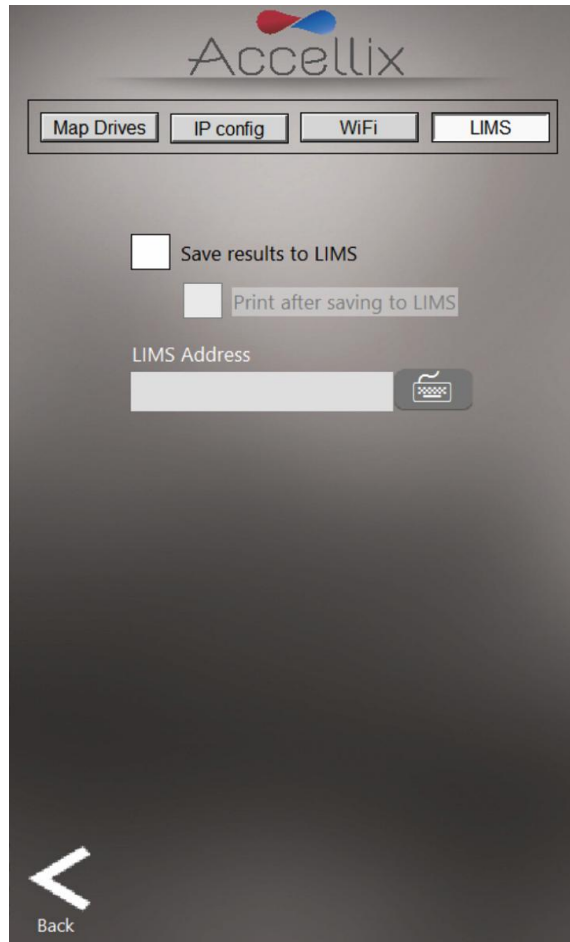

Figure 27: Network screen: LIMS tab

9.4.8. Auto-Classification Subscriptions Function



The **Auto-Classification Subscriptions function** Subscriptions screen allows the user to view and add auto-classification (AC) subscriptions for any applicable assays (Figure 28). For more information, please contact sales@accellix.com.

Note: This function is by default turned off unless turned on by Accellix.

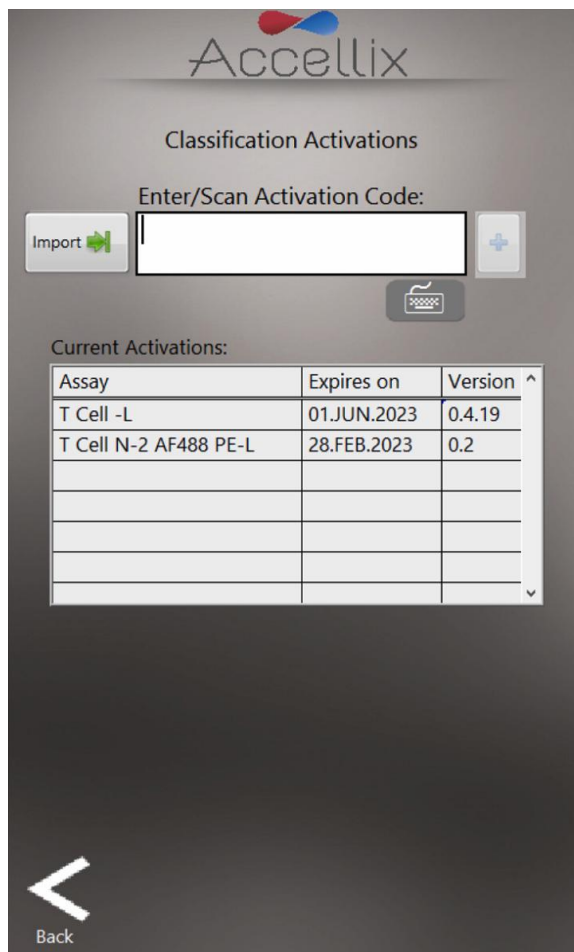



Figure 28: Auto-classification Subscriptions screen

The table displays all the subscriptions currently installed with the Assay name, the date its subscription has expired or will expire, and the version number.

Auto-classification subscription codes are provided by an Accellix Representative, to add a subscription, click on the **Import** button () and navigate to the subscription file sent by Accellix in the resulting file dialog window. Selecting the file will either add the assay to the list (if it is not already present) or update its expiration date (if it already exists in the list). For more information or assistance, please contact sales@accellix.com.

9.4.9. Backup Options & Destination

9.4.9.1 Backup Options

This setting determines what results will be copied to the destination location at the conclusion of an assay run. There are 3 options:

1. Results files only: this includes Assay Results.pdf, Events.csv, Events.fcs and Summary Results.txt.
2. Results + raw (bin): same as option 2 above, but also includes the raw binary bin file.
3. All files.

9.4.9.2 Destination Location

The destination where the results should be copied is displayed in the field directly below the Copy options. Set the path by using the folder icon  next to the destination location field (see red box in Figure 29).

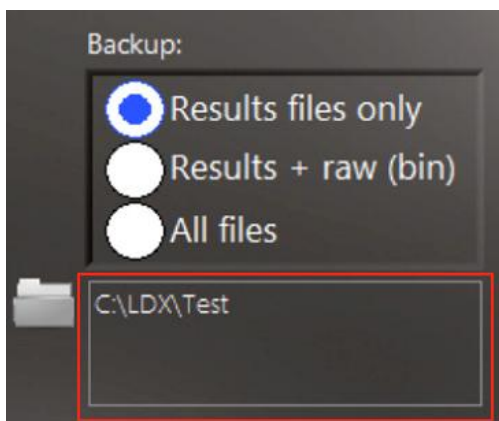

Figure 29: Copy and Destination Location section

Tapping the folder icon displays the **Set Data Destination Configuration** screen (Figure 30):

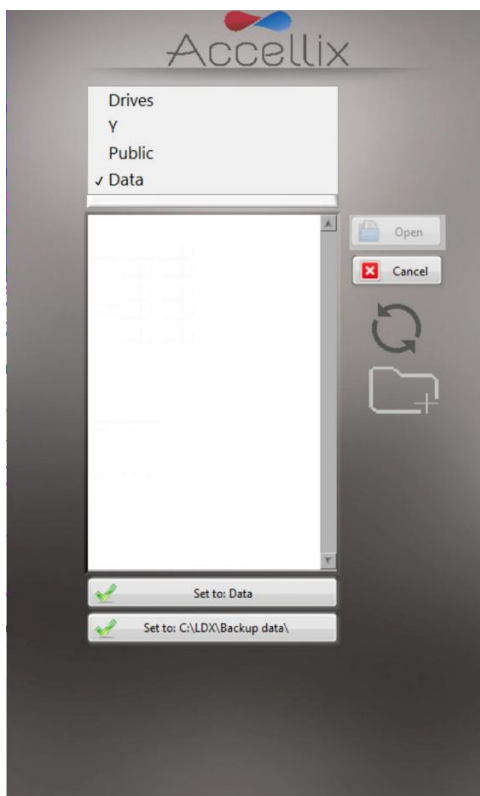





Figure 30: Set Data Destination Configuration screen

- The pop-up menu allows the user to navigate up the folder structure hierarchy where the current folder selected is located at the bottom. To select the relevant path, select the specific location by double clicking on it or using the “Open” button and then tap the “Set to” button, which contains the name of the final data folder.
- The contents of the currently selected folder are displayed in the list box below the pop-up menu. Selecting **Drives** in the pop-up menu will display a list of all available drives in the list box.
- If the software is configured to allow saving to a specific folder on the internal hard disk (C:\) a button will appear below the “Set to” button.
- For each destination location, the user can create a new folder and choose it accordingly.

Figure 30 icon key:

-  Saves the current folder as the destination folder for all data to be copied.
-  Cancels any changes and leaves the destination location the same as it was before entering this screen.
-  Refreshes the currently selected folder and updates the list of contents.
-  Allows the user to create a new folder within the current folder.

9.4.9.3 Limit Cartridge Folders Function

All files, including raw data files, results reports, etc., generated by the instrument for any test run are automatically stored in the instrument’s internal hard disk. The internal hard disk is not accessible, however, the existing data can be copied manually subject to the instrument’s configuration.

Note: The raw data (.bin) files are each approximately 1.25 GB. When the **Limit Cartridge Folders** to checkbox is selected (Figure 31), the software retains only the newest *N* folders (where *N* is the number typed in the field next to **Limit Cartridge Folders to**). All older cartridge data folders are deleted.

Warning: Deleted data cannot be restored.

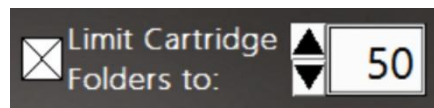

Figure 31: Limit Cartridge Data Folders controls

Note: If the instrument is configured to back up the data to a location on the internal hard disk (C:\), a second option appears (Limit Backup folders) . Checking this box limits the number of folders in the C drive backup folder (Figure 32).

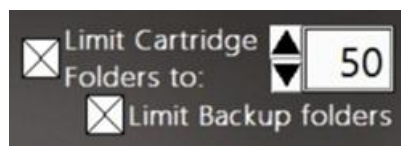

Figure 32: Limit Cartridge Data & Backup Folders controls

10. Operator Start Screen

When an operator logs in or if logins are disabled, the main Accellix Start screen is displayed as shown in Figure 33:

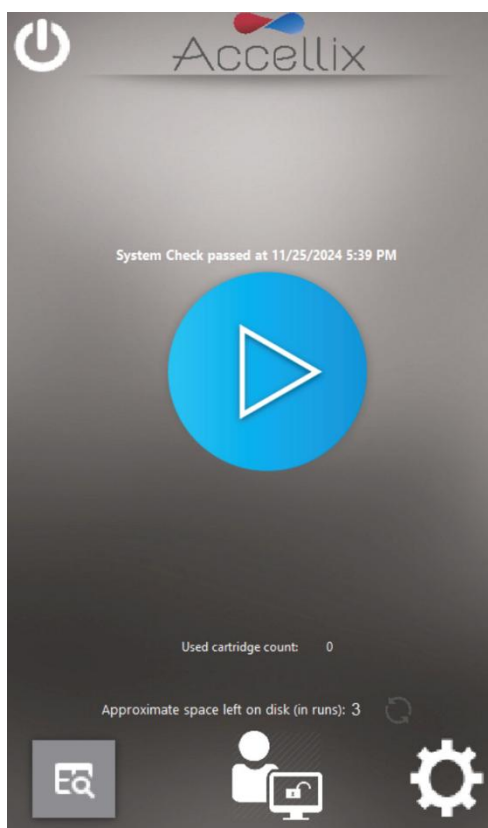

Figure 33: Start screen

Note: Depending on instrument configuration, the **Audit Trail** , **Administrator** and **Settings** icons may or may not be visible.

Note: The System Check message above the blue Start button only appears after a successful System Check. Any action (e.g., logging out, starting an assay or accessing any of the buttons along the bottom of the screen) will remove the message until the next System Check is performed successfully. A System Check is performed automatically at midnight if the instrument is powered on and no assay is running. If an assay is running, the instrument will keep trying until 2am.

Note: If auto-classification subscriptions are enabled and an assay's subscription is due to expire within the next 6 weeks, the assay's name and expiration date will appear in **yellow** in a table above the blue Start button. If an assay's subscription has already expired, the assay name and expiration will appear in **red** (Figure 34).

Note: If any files were not successfully copied to the backup location, a yellow warning triangle button with an exclamation mark (!) will appear below the blue **Start** button. Clicking this button will display the Show Errors screen (see section 9.4.6 Errors).

Note: If the Preventative Maintenance (PM) date has passed for an instrument, a warning will appear below the blue **Start** button. Please contact Accellix support to schedule the maintenance as soon as possible.

Note: The free space available on the instrument's internal hard disk is displayed as a function of the total number of assays that can be run. Press the Refresh icon () located near the bottom of the display to refresh this number after manually deleting files.

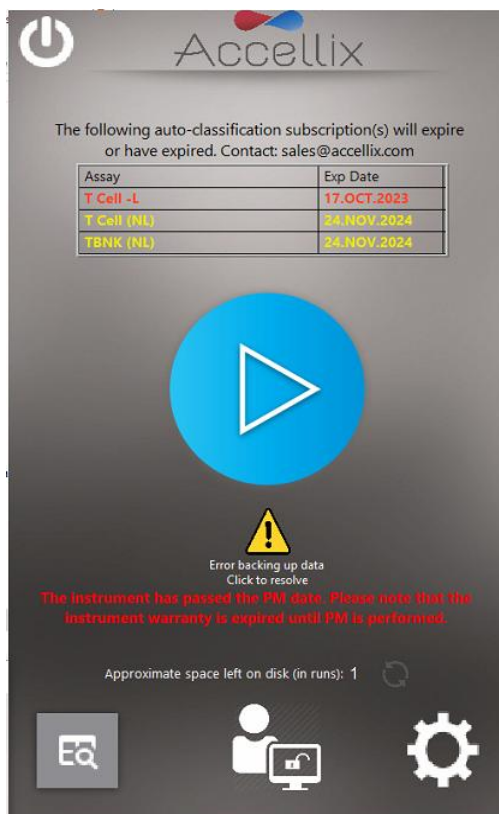



Figure 34: Start screen with login enabled, showing subscription status, recopy button and PM status



To view the Audit Trail (if enabled for Operators), tap on the View Audit Trail button. . See section 9.3 for details.



To view the Administrator Functions screen, tap on the Admin Functions icon . See section 9.4 for details.



To view the Settings screen, tap on the Settings icon . See section 9.2 for details.

11. Operating the Accellix Platform

To ensure the successful operation of the Accellix Platform, a user is expected to undergo basic training procedures. This training includes instructions on operating the instrument (as outlined in the Accellix User Manual and Instructions For Use), safety procedures, troubleshooting techniques, and guidelines on when to contact the manufacturer for service. This training should be performed by an Accellix representative, or by an experienced and trained user.

The Accellix platform performs flow cytometric analysis of a sample according to test parameters defined in the technical data sheet of the relevant assay.

11.1. To Run an Assay on the Accellix Instrument:

1. If logins are enabled, select an Operator and log in (the **Start** screen will appear).
2. Follow the “Instructions for Use” for the applicable assay to load sample into the cartridge. Find the relevant Technical Data Sheet and Instructions for Use here: <https://www.accellix.com/technical-resources/>.

3. Run an assay as follows:

On the **Start** screen display, tap the **Start** icon  and follow the instructions displayed on the instrument's screen.

Note: From this point forward, the highlighted gray dot at the bottom of the screen shows the current stage of the assay run. (See Figure 35).

4. When prompted by the instrument (Figure 35), open the door by pressing down on the front right-hand indent corner of the door and releasing. Next, insert the cartridge into the instrument by pushing it down using the top handle. Once the cartridge is inserted, push the handle on the right-hand side a bit more until a click is heard and felt, ensuring that the cartridge has been inserted fully into the instrument Cartridge Handling Unit (CHU).

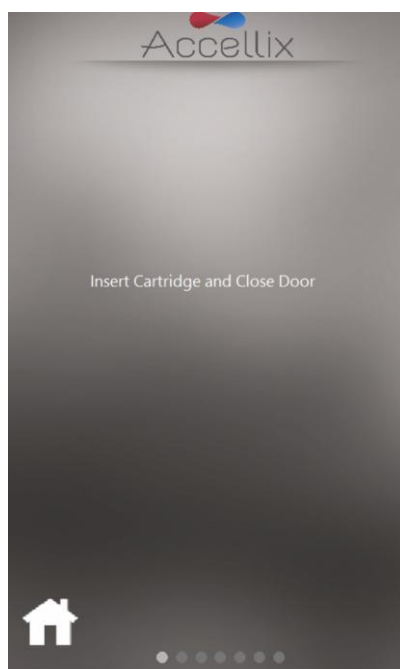

Figure 35: Insert Cartridge screen

5. The screen instructs the user to wait while the instrument reads and registers the QR code information on the cartridge (Figure 36).

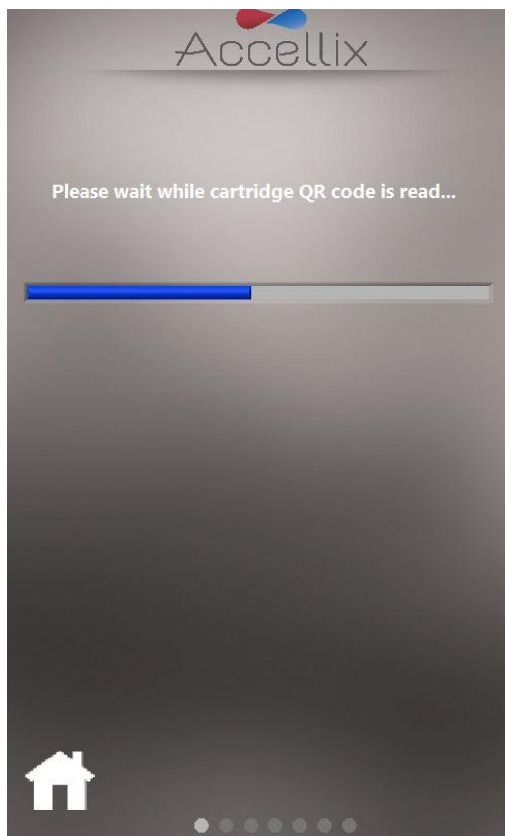

Figure 36: Reading Cartridge QR Code screen

6. On the **Enter Sample ID screen** (Figure 38), enter the Sample ID using the on-screen keypad, an external keyboard or barcode scanner. The Sample ID will then be displayed on all subsequent screens of the assay run.

Note: To proceed, at least one character must be entered as the Sample ID. It can not be any of the following characters or only spaces: * \ / " : < > ? | _ % # & { } \$! ' @ [] ;

Note: The  icon shows and hides a list of all forbidden characters.

Note: In an optional configuration of the software, the user is also required to enter a Kit Lot Number. (See the image on the right-hand side of Figure 38).

Note: Tapping on the Home button will abort running the assay. After the cartridge is removed and the door is closed, the Start screen will appear.

Note: Some instruments may be configured to allow for a “Control Sample” to be run. In this case, an additional option appears above the Sample ID field (if the current assay can be run as a control sample) to allow for setting the run as a control sample run as illustrated in Figure 41:

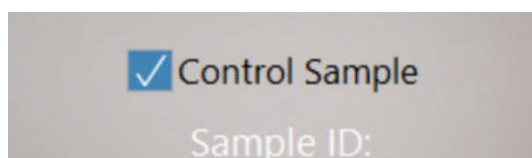

Figure 37: Control Sample Button

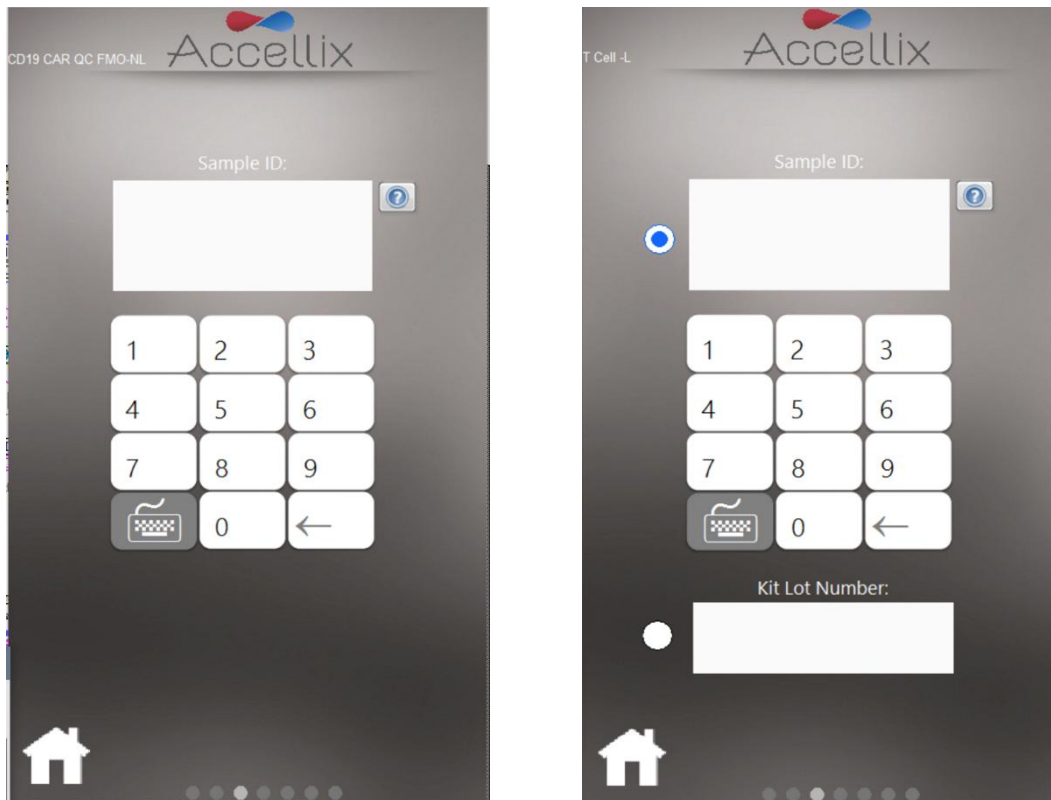



Figure 38: Enter Sample ID screen (with and without Kit Lot Number)

7. Once the Sample ID (and Kit Lot Number, if applicable) field is no longer empty, the Next  icon will appear.
8. Tap **Next** to continue.
9. The **Confirmation screen** (Figure 39) now displays the assay/cartridge type and Sample ID (and kit number if so configured). The user must confirm these details before starting the assay run by tapping **Next**.

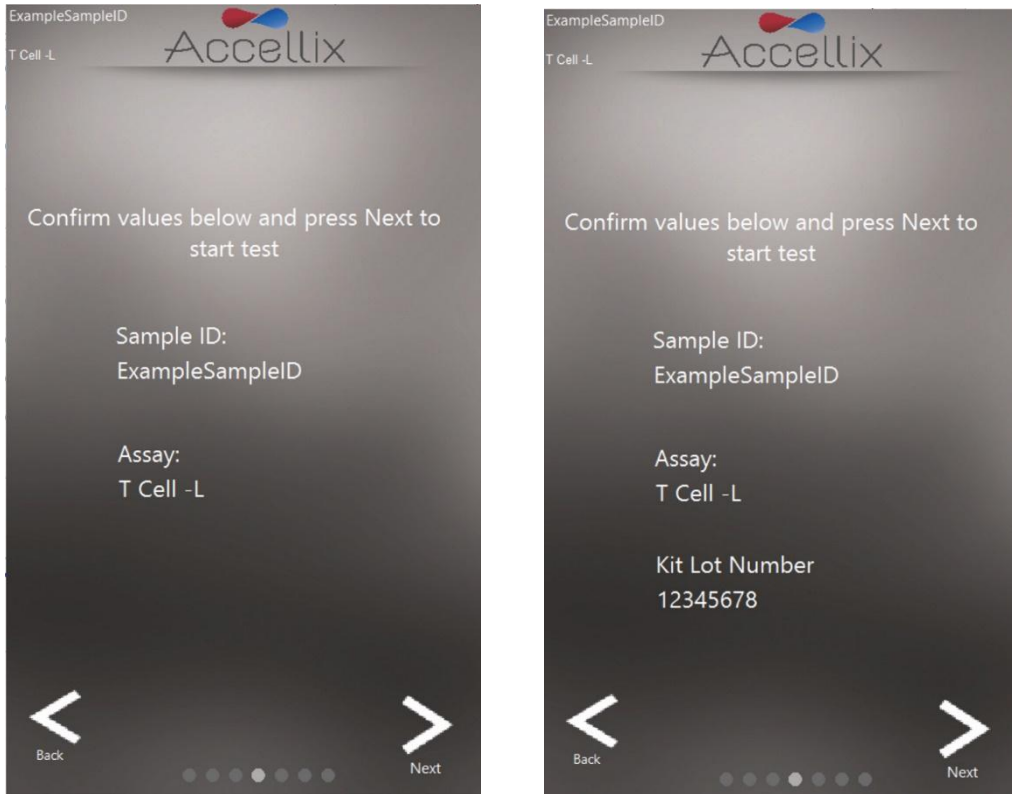
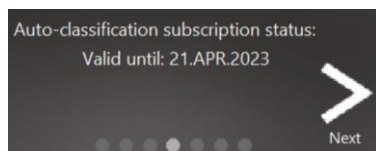

Figure 39: Confirm Sample ID and Assay/Cartridge screen (with and without Kit Lot Number)

Note: Tapping on the **Back** icon will return the user to the Sample ID screen. This is useful if incorrect information was entered, or the run needs to be stopped for any reason.

Note: Auto-classification subscriptions are by default turned off, but if they are activated and the selected assay requires an active subscription, a message will be displayed at the bottom of the confirmation screen. Any one of the four following messages can appear depending on the status of the subscription:



This will appear if the auto-classification subscription is valid and is not due to expire within the next 6 weeks.

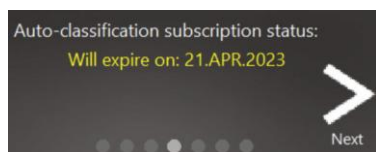

This will appear if the auto-classification subscription is valid but is due to expire within the next 6 weeks.

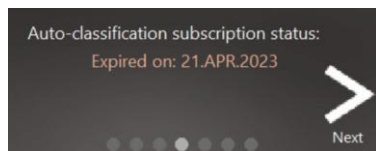

This will appear if the auto-classification subscription has expired. In this case, only Total Bead Count results will be displayed.

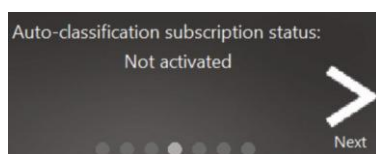

This will appear if auto-classification subscription is not activated for the selected assay.

Note: If the selected assay has been set in the Sample ID screen to be run as a control sample, then text will appear on the Confirmation screen indicating that this is a control sample run as illustrated in Figure 40.

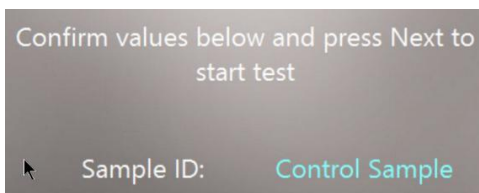

Figure 40: Control Sample confirmation message

10. After tapping **Next**, the test proceeds in accordance with the specific parameters relevant to selected assay/cartridge type.

Note: Once the **Next** button is pressed on this screen a cartridge is considered used and cannot be reused.

11. The **Progress screen** (Figure 41) displays a progress indicator and a **Time Remaining** countdown timer. The user can monitor the test progress and approximate time remaining.

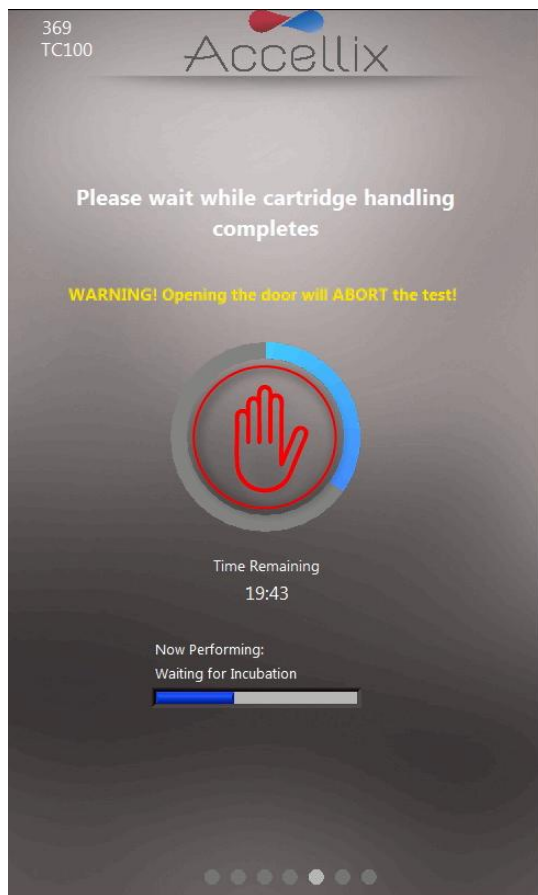

Figure 41: Progress Indicator and Time Remaining screen

Warning

Aborting a Running Assay: Do not open the instrument door while an assay is in progress as this will cause the assay to abort. A cartridge should only be removed from the instrument once the “Open door and remove cartridge” message appears on the screen.



Note: To stop an assay that is in progress, the user can tap **Stop**, the red hand at the center of the progress indicator (see Figure 41). Refer to Section **11.3** Termination of an Assay Run.

Note: When aborting an assay by tapping **Stop**, confirmation is required from the user to proceed with the abort and a dialog box will appear, requesting the user to add “Reason Aborted.” If so configured, a comment may be mandatory.

Note: If a physical keyboard is not attached to the instrument, a virtual keyboard can be displayed by tapping on the keyboard icon.

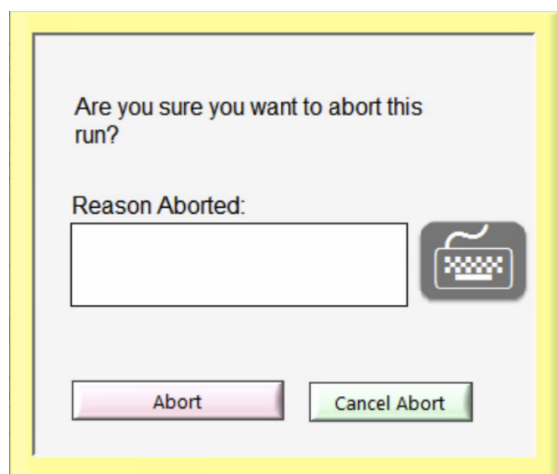

Figure 42: Confirm Abort Dialog

12. Upon completion of the assay, the results are copied to the designated backup location. The instrument notifies the user by displaying one of four possible results screens, depending on the assay configuration: No Results, Pass/Fail, Total Bead Count only or an on-screen table with all results.

The following two screens are examples of potential result displays (Figure 43 and Figure 44):

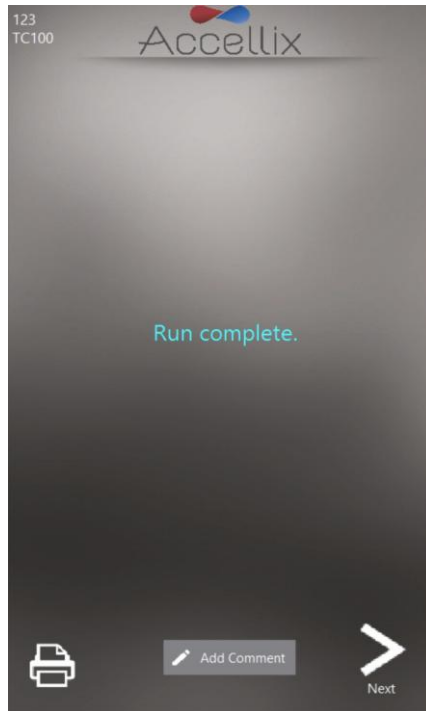

Figure 43: Example of Run Complete with no results screen

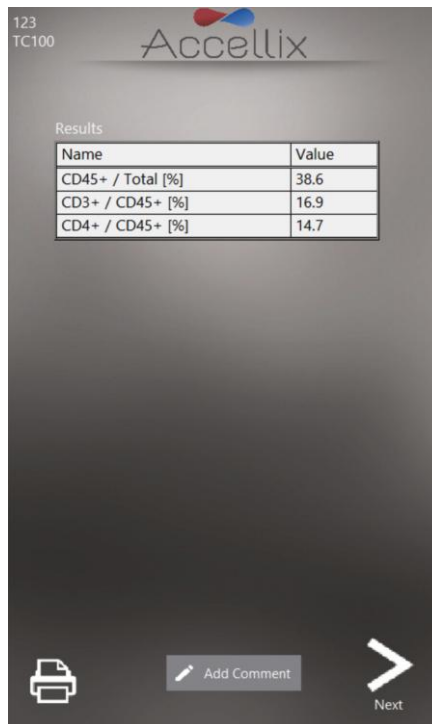



Figure 44: Example of on-screen Results report

- a. For an assay which produces an on-screen results report, e.g., T Cell RTF (L) Assay, a **Results** screen will be displayed on the screen at this point. See example of on-screen **Results** report in Figure 44.
- b. For an assay which generates a **Results** output, a printable report will also be generated. The instrument can be configured to automatically print at the conclusion of a run.
 - If automatic printout was not configured or if the user chooses to print to an alternate printer, a manual printout can now be initiated by tapping on the **Printer**  icon at the bottom-left of the **Results** screen. The user may select desired printer from the **Printers** list, and then tap **Printer** icon to execute the manual printout.

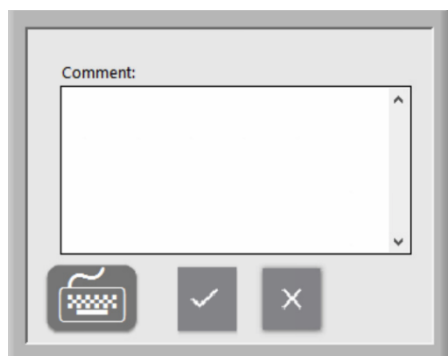



Figure 45: Comment window

- If desired, a comment can be added to the Assay Results.pdf by tapping on the **Add Comment** button. This will open a window where the user can add a comment (Figure 45).

Note: A new PDF called “Assay Results with Comment.pdf” is generated if a comment is added. This PDF will be copied to the backup location once the Next button is tapped on the Results screen.

Note: A virtual keyboard can be displayed by tapping on the keyboard icon if a physical keyboard is not attached to the instrument.

13. Tap the **Next**  icon when ready to conclude the assay process.
14. On-screen instructions (Figure 46) prompt the user to open the instrument door, remove the cartridge, and finally to close the instrument door.

Note: It is important that the instrument door remains closed between assay runs to prevent foreign particles from entering the instrument interior.

Note: In the case of an auto-classification error, the Results screen will display the error. Please see Troubleshooting section for more details.

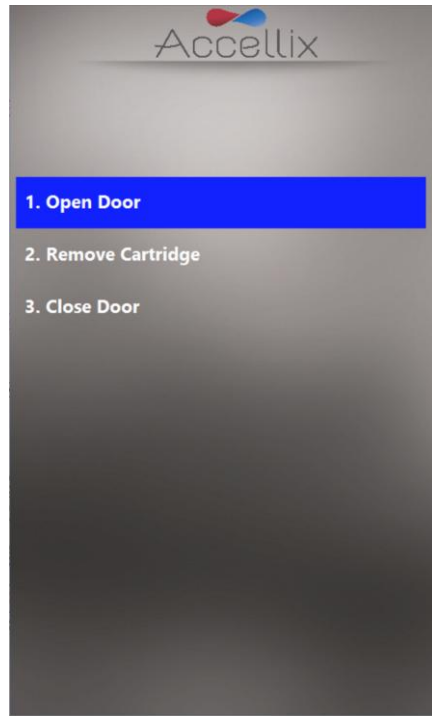

Figure 46: Remove Cartridge screen

15. The software returns to the **Start** screen.
16. The cartridge should now be disposed of in a suitable biohazard waste receptacle in accordance with organizational policy and/or local regulations.

11.2. TO RUN A MULTI-CARTRIDGE ASSAY

1. The **Multi-Cartridge Remove** screen instructs the user to remove the first cartridge and insert the next cartridge in the sequence (Figure 47).

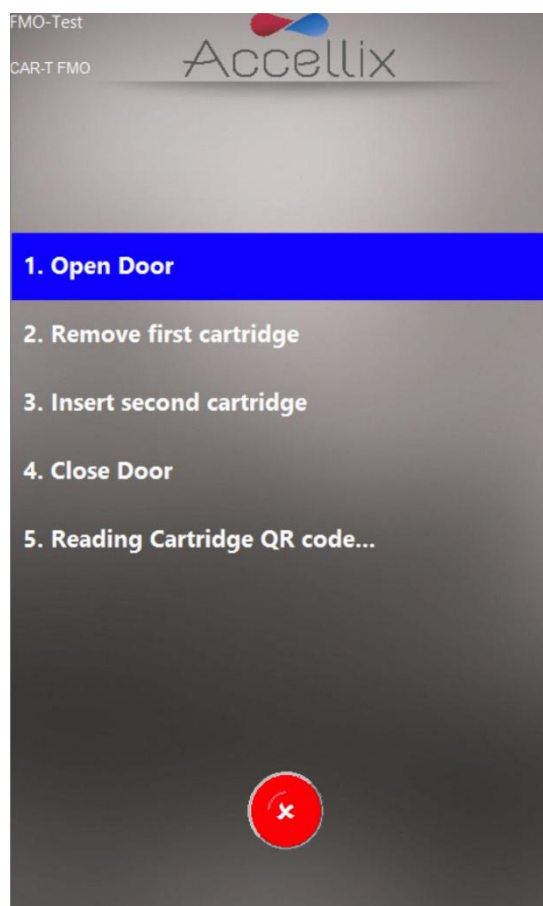



Figure 47: Multi-Cartridge Remove screen

2. If the user inserts the cartridges of a multi-cartridge assay in the wrong order, the user will be instructed to remove the incorrect cartridge and replace it with the correct one. The software scans the QR code upon insertion of the next cartridge to verify that it is the correct type to run next.

Note: If the user wants to abort the multi-cartridge assay in-between the two cartridge runs, tapping the red **Abort**  icon will terminate the assay.

3. Once the correct next cartridge of a multi-cartridge assay has been inserted, the software will display the **Confirm Sample ID and Assay/Cartridge** screen (Figure 39) and proceed with the assay run.

11.3. Termination of an Assay Run



The **Stop** icon may be used to terminate an assay run (Figure 41).

If an assay is stopped during a run, a message will be displayed on the screen (Figure 48). During this time, the system returns the cartridge to its home position. It is important to note that the homing of cartridge may take some time (generally not more than one minute), as the test scripts must be aborted, and internal motors move back to their home positions. Please be patient while the system completes this operation.

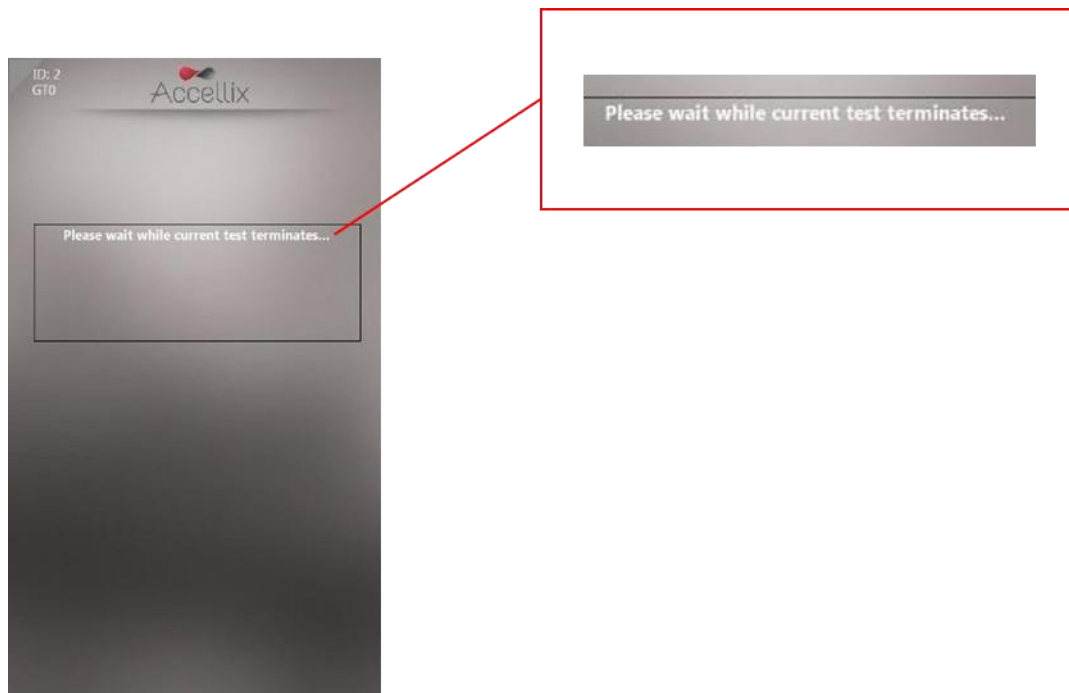



Figure 48: On-screen message following termination of assay run

Note: The cartridge should only be removed from the instrument after the user receives a prompt on the display panel that it is safe to do so.

12. Shutting Down the Instrument

The instrument should be left powered on when not in use, however, for extended periods of inactivity, the instrument should be turned off.

To shut down the Instrument:

1. On the **Start** screen (if logins are disabled) or on the Login screen (if logins are enabled), tap the **Shutdown**  icon.

The user is prompted to confirm the shut down (Figure 49).



Figure 49: Confirm Shut Down screen

2. Shutting down the instrument is a 2-step process:
 - a. Tap the **Shutdown** icon to start the power down sequence.
 - b. Once the instrument's screen is black, it is safe to turn off the physical power switch on the rear panel of the instrument. Shutdown is completed only after the power switch on the rear panel of the instrument is in the **OFF** position.

Note: It is not possible to shut down the instrument with a cartridge inside. The **Shutdown** button will be disabled until the cartridge is removed and the door is closed (these instructions will be displayed to the user on the screen if a cartridge is in the instrument).

13. Troubleshooting

There are four potential types of unexpected issues which can arise when using the Accellix instrument:

- Cartridge related issues
- Instrument related issues
- Operator error
- All administrators locked out

Note: For more details, refer to the Accellix Instrument Troubleshooting User Manual which is available in the Resources section on our website, www.accellix.com.

13.1. CARTRIDGE ISSUES

The following scenarios may invalidate a cartridge run:

- The system does not recognize the cartridge QR code.
- The cartridge is past its expiration date.
- Analysis of the sample fails.
- Run aborted due to door opened during run.
- Tampering with the cartridge components.
- Not following recommended Instructions For Use.
- Insertion / focus errors.

Specific instructions for each error type are provided on-screen. An example is illustrated in Figure 50:



Figure 50: Example of an Error Message

In all such cases (except for auto-classification errors) the cartridge should be removed, and the door closed to return to the **Start** screen.

In the case of most classification errors, an error will appear on the screen describing the situation and what to do. An example is illustrated in Figure 51:

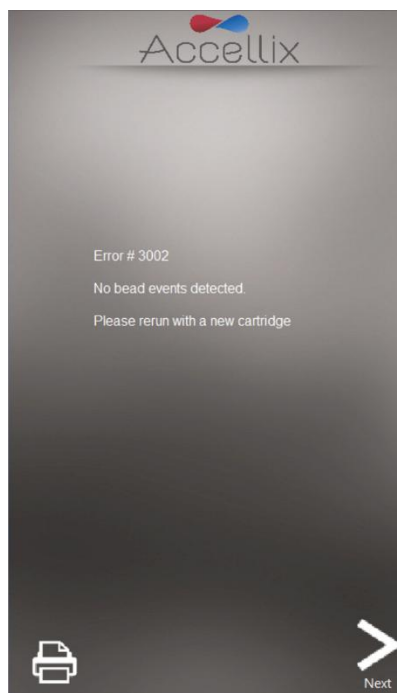

Figure 51: Auto-classification Error example

In the case of the first cartridge of a dual cartridge assay that fails Auto-classification, the user will be given the option of aborting the assay or continuing to the second cartridge as illustrated in Figure 52.

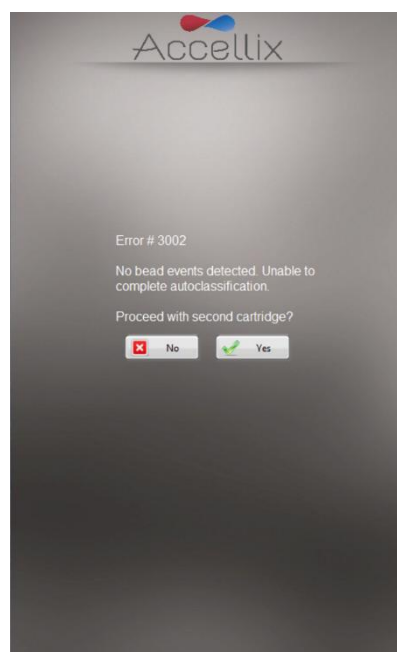



Figure 52: First Cartridge Auto-classification Error

13.2. INSTRUMENT ISSUES

With the exception of the **Hard Disk Full** warning and **Network Errors** (see below), recovery from abnormal instrument behaviors can be performed by tapping the **System Check**  icon or by turning the instrument off and then back on again (see Section 0- To shut down the Instrument and Section 7 – **Starting the Instrument**).

A **System Check** performs various maintenance and hardware checks to ensure the instrument's hardware is functioning correctly. Parameters checked include (but are not limited to) testing the controller board, motors, laser, cameras, LEDs, and data acquisition.

Upon completion of a successful System Check, the system returns to the **Start** screen to allow the user to run another test. If the System Check encounters an error, an error message will pop up on the screen. Follow directions in the error message, if applicable. Administrators can access and review any errors in the Audit Trail. Please report any errors encountered including the circumstances leading to the error(s) to Accellix Support (support@accellix.com). **Appendix E – User Support & Manufacturer Contact Information.**

Hard Disk Full warning:

The Accellix Instrument stores data files generated for each assay on its internal hard disk, which can reach capacity over time as more assay runs are completed. Prior to running an assay, the instrument checks to make sure that there is enough hard disk space to successfully complete and save the data. If the **Hard Disk Full** warning (Figure 53) is displayed, hard disk space must be freed prior to initiating a new assay run.

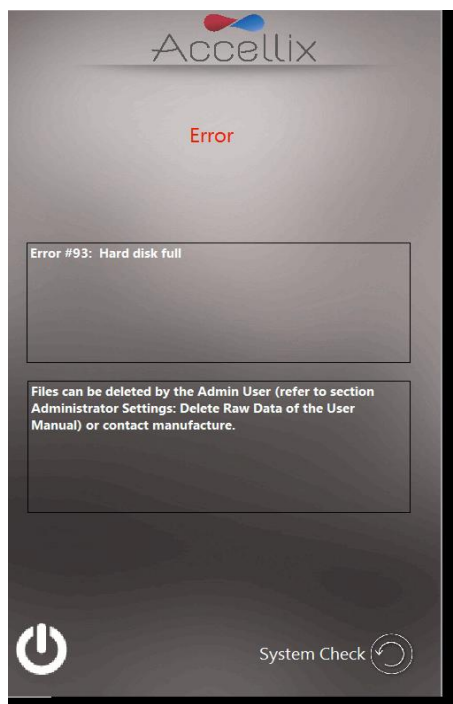



Figure 53: Hard Disk Full warning screen

Hard disk space can be freed by the Administrator using the **Delete Raw Data**  function (See **GENERAL ADMINISTRATOR**) or by using the **Move** option from the **Copy Files** function (Figure 19). If necessary, contact Accellix Support for assistance.

Touchscreen Issues:

If the touchscreen does not respond, shut down the instrument following directions in Section 12 (Shutting down the instrument), and switch the instrument back on following directions in Section 7

(Starting the instrument). Another temporary option is to connect an external mouse and keyboard, and/or a barcode scanner as described in Section 6.2 INSTALLATION OF COMPUTER HARDWARE. If the issue persists, contact Accellix Support for assistance.

Network Errors:

If a network outage occurs during the data backup process, the instrument will make up to three attempts to complete the backup. However, if the backup fails after multiple retries, any files not copied will be added to the list of files which need to be manually copied. See section 9.4.6 for details about recopying files.

Other Issues:

In rare instances, inaccurate results may occur due to incorrect operation of the instrument. The instrument should be used in strict accordance with this User Manual. Contact Accellix Support if the system does not start, if instrument performance issues are suspected, or for further troubleshooting assistance.

System Self-Check Actions:

When a System Self-Check is initiated, the software will check the following hardware components to validate that they are functioning correctly:

- Laser intensity
- Cameras
- Motors
- LEDs
- SiPM measurements
- Controller Board communication
- R Server (for data analysis and computer vision)

13.3. ALL ADMINISTRATORS LOCKED OUT

Should all administrators be locked out for any reason, the **Reset Passwords** button will appear just above the list of administrator names (see Figure 54).

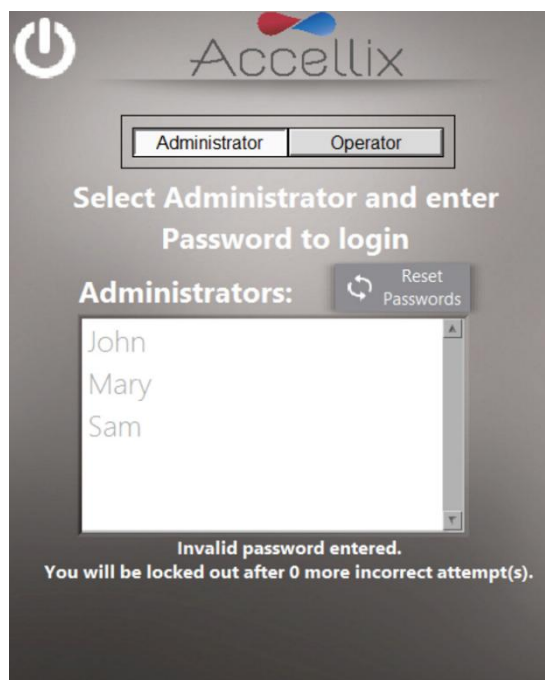

Figure 54 - Reset Passwords button on Login screen

Pressing this button will display the screen shown in Figure 55:

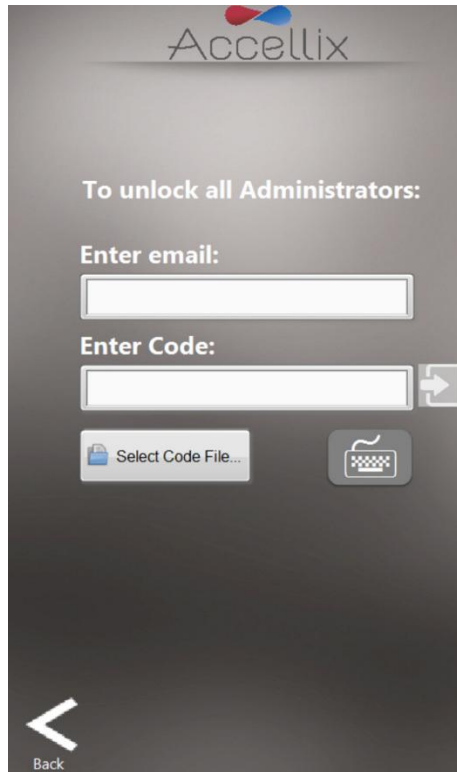

Figure 55: Reset Admin Passwords screen

To unlock all Administrators, email support@accellix.com to request a code. Enter the same email address used to contact Support and type in the unlock code in the **Enter Code** field (Figure 55).

Click the Login button  to unlock all administrators.

Note: Accellix will also send a file containing the code which can alternatively be used instead of typing the code in manually. To use the code file, click on **Select Code File** icon (Figure 55) to select the file.

Press the **Back** button to return to the Login screen.

14. Handling Instructions

Handle the instrument with care. Once installed, the instrument should not be moved. If the instrument requires moving after installation, contact Accellix Support.

Protect the system from direct sunlight, humidity, and dust.

Operate only at permitted environmental operating conditions, as follows:

- Operating Temperature: 20-25°C (68-77°F)
- Maximum Relative Humidity 85%, non-condensing

For information on instrument dimensions and power, refer to **Appendix A – Technical Specifications**.

15. Maintenance

Annual maintenance of the instrument is recommended. For safety and best results, take note of the following:

- **On-screen Instructions:** If an error occurs, the operator should follow any on-screen instructions. (See Section 13 Troubleshooting)
- **Laser Safety:** This instrument is classified as a Class 1 Laser product, according to IEC-60825-1 edition 3. Internally, the instrument uses a 50mW, 488nm Class 3B laser. Do not open the side covers that enclose the laser. The instrument is tested and adheres to the safety regulations outlined in the aforementioned standard, entitled Safety of laser products -Part 1: Equipment classification and requirements, and its EN equivalent.
- **Network Connectivity:** To connect the instrument to a local area network (LAN), Wi-Fi network, or to a network printer, seek assistance from qualified IT personnel. (Connection to a LAN should be performed using a cable that is less than 3 meters in length.)
- **Cleaning the System:** Accellix instrument may require cleaning periodically. To maintain the integrity of all Accellix components, perform cleaning according to the following procedure: Wipe the affected instrument surface with any of the materials listed in the **Decontamination** section below. Follow the directions provided with the cleaning product.
- **Decontamination:** If a cartridge is damaged after being inserted into the instrument, biohazardous material may leak into the instrument. In such a case, wipe down the front, sides and top of the instrument with Pursept[®] disinfecting wipes, Medipal 3in1[®] Disinfectant Wipes, or other similar ethanol-based wipe. To thoroughly clean the CHU opening, a wipe wrapped around a long Q-tip can be used. All blood products should be treated as if they may contain pathogens.
- **Disposal Procedure:** The instrument should be disposed of according to local regulations regarding electronics and medical equipment waste. Used cartridges are considered a biohazard and should be disposed of in accordance with local regulations.
- **Service Manual:** Servicing should not be performed by the user. All servicing must be performed by an Accellix representative. For servicing, contact Accellix Support at support@accellix.com) and/or see manufacturer website at www.accellix.com.
- **Shipment for Repair:** If an instrument needs to be returned to Accellix for repairs, contact support at support@accellix.com. If the instrument has been used with biohazardous samples, after cleaning as per the above instructions, it should be enclosed in the provided biohazard bag before proceeding. Further packaging steps should be performed only as instructed by an Accellix Support personnel.
- **Self-Check:** The instrument automatically performs a self-check to test and verify its functionality.

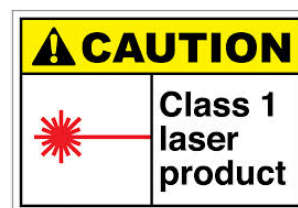

16. Assay-Specific Information

Assay-specific information is provided in the Technical Data Sheet and Instructions for Use for that specific assay (see [accellix.com/accellix-assays](https://www.accellix.com/accellix-assays)).

Appendix A – Technical Specifications







INSTRUMENT DESCRIPTION	SPECIFICATION
Instrument Dimensions	37 x 23 x 51 cm; 13.5 kg
Electrical Requirements	100-230V AC, 50/60Hz; Power draw: steady-state 35W, peak 90W
Replaceable Fuse	250V, 3A
Operating environment	Operating Temperature: 20-25°C (68-77°F) (max. rel. humidity: 85%, non-condensing) System should be protected from exposure to direct sunlight, humidity, & dust Instrument should have clearance of at least 20cm (8 inches) from both sides
Excitation Laser	488nm, cyan (40-50mW)
Fluorescence Detector	High-performance SiPM (silicon photomultiplier) array (11 channels)

INSTRUMENT DESCRIPTION	SPECIFICATION
Fluorescence Detection Range	510–800 nm
Forward Scatter Detection	Si PD (silicon photodiode); Collection angle: 6-11deg
Focus and Alignment of Optical platform	Real-time focus and excitation alignment, utilizing proprietary image analysis control algorithm
DAQ A/D Resolution, Sampling Rate	16-bit, 100kHz
Software	Accellix custom software, running on embedded PC; Operating System is Windows 10® Enterprise 2016 LTSB (64-bit)
Test Run Automation	Via control of instrument motors that provide functionalities including the following: <ul style="list-style-type: none"> • Auto-focus • Auto-alignment • Reagent injection/fluid release from cartridge blisters (x3) • Sample mixing • Sample reading

CARTRIDGE DESCRIPTION	SPECIFICATION
Cartridge Dimensions	7.9 x 8.5 x 1.2cm
Performance Characteristics	See assay kit Technical Data Sheet
Sample Carryover	None, due to single-use cartridge
Sample Type, Sample Volume, Sample Limitations	Assay-specific and test-specific information can be found in the Technical Data Sheet included with assay kit
Cartridge Backbone Material	Cyclic olefin copolymer (COC)

CARTRIDGE DESCRIPTION	SPECIFICATION
Cartridge Automation	<p>The following are general capabilities:</p> <ul style="list-style-type: none"> • Up to three reagent injection steps. Each step enables mixing and incubation time for cell staining. • Automated sample reading. • Automated data analysis, which provides the user with analyzed data file, e.g. event detection record in .fcs and .csv file formats.

Appendix B – Symbols

SYMBOL	USED FOR:
	Manufacturer
	Serial Number
	CE Mark
	TUV Mark
	Consult instructions for use
	Environmentally-friendly use period. The actual number of years may vary by product. This symbol is typically orange in color.

Appendix C – Sample Product Label

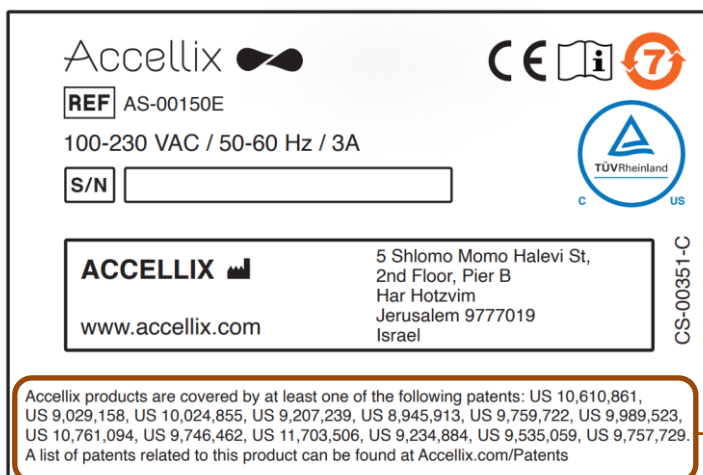

1.

1. Accellix products may be covered under one or more patents in the U.S. and elsewhere. Additional patents may be pending in the U.S. and elsewhere. This system and cartridge are covered by, or are for the use in the method of the following issued patents: US 9,029,158 US 9,234,884 US 9,535,059 US 9,757,729

A list of patents related to this product can be found at [Accellix.com/Patents](https://www.accellix.com/Patents)

Appendix D – Safety Information

- **Laser exposure:** Do not open the cartridge handling unit (CHU) door while the instrument is processing a sample, as this will cause the assay to be aborted. This is designed to prevent the user from being exposed to the laser while the laser is active.
- **Cartridge- and assay-specific safety issues:** Refer to the Technical Data Sheet included with assay kit.
- **Cartridge disposal:** Dispose of the cartridge as a biohazard in accordance with local regulations.
- **Electrical safety:** The instrument complies with the following standards:
 1. IEC/EN61010-1
 - Including CAN/CSA-C22.2 NO. 61010-1 and UL 61010-1
 - Safety requirements for electrical equipment for measurement, control, and laboratory use - Part 1: General requirements
 2. EN IEC 61010-2-081
 - Including CSA C22.2 No. 61010-2-081 and UL61010-2-081
 - Safety requirements for electrical equipment for measurement, control, and laboratory use - Part 2-081: Particular requirements for automatic and semi-automatic laboratory equipment for analysis and other purposes
 3. EN IEC 61326-1 EMC emission and immunity requirements
 4. FCC compliance statement: This instrument complies with part 15 of the FCC Rules. Operation is subject to the following two conditions:
 - a. This instrument may not cause harmful interference, and
 - b. This instrument must accept any interference received, including interference that may cause undesired operation.
 5. Per China MIIT Notice No.52 on regulation of micropower equipment:
 - a. The use of the equipment shall comply with the specific provisions and usage scenario, type and performance of the antenna adopted, and the method to control, adjust and switch the equipment in the “Catalogue of Micro-power Short-range Ratio Transmission Equipment and Technical Requirements”;
 - b. It is not allowed to arbitrarily change the usage scenario or usage condition, expand the transmission frequency range, increase the transmission power (including additional installation of radio frequency power amplifier) or arbitrarily change the transmission antenna;
 - c. No harmful interference may be caused to any other legitimate radio station, and no protection against harmful interference may be required;
 - d. It shall withstand the interferences from industrial, scientific and medical (ISM) application instruments radiating RF energy or interference from other legitimate radio stations;
 - e. If harmful interferences are caused to other legitimate radio stations, the use of radio transmission equipment shall be stopped immediately, and can only be continued after measures have been taken to eliminate the interference;

- f. For the use of micro-power equipment in aircrafts, in military and civil radio stations established according to the laws & regulations and relevant regulations of the state, such as the radio observatories, meteorological radar stations, satellite earth stations (including measurement and control station, ranging station, receiving station and navigation station), in airports and other electromagnetic environmental protection areas, it is required to comply with the provisions for electromagnetic environmental protection as well as the regulations of competent authorities of relevant industries;
- g. No remote controller is accessible to the area centering at the center point of runway and in 5000 m radius;
- h. The environmental conditions of temperature and voltage in the use of micro-power equipment shall meet the operating environment and electrical requirements outlined in **Appendix A – Technical Specifications**.

Note: Protection provided by the equipment can be impaired if the instrument is used in a manner not specified by the manufacturer.

Appendix E – User Support & Manufacturer Contact Information

Accellix User Support

Accellix, Inc.
2385 Bering Drive
San Jose, CA 5131, U.S.A.
Tel: 650-396-3035
Email: support@accellix.com



Accellix, Ltd.
5 Shlomo Momo Halevi Street
2nd Floor, Pier B;
Har Hotzvim
P.O. Box 45409
Jerusalem 9777019, Israel
Tel: +972-2-674-4422
Fax: +972-2-674-4455
Email: office@accellix.com